

ZON™

BEARINGS FOR YOUR FUTURE

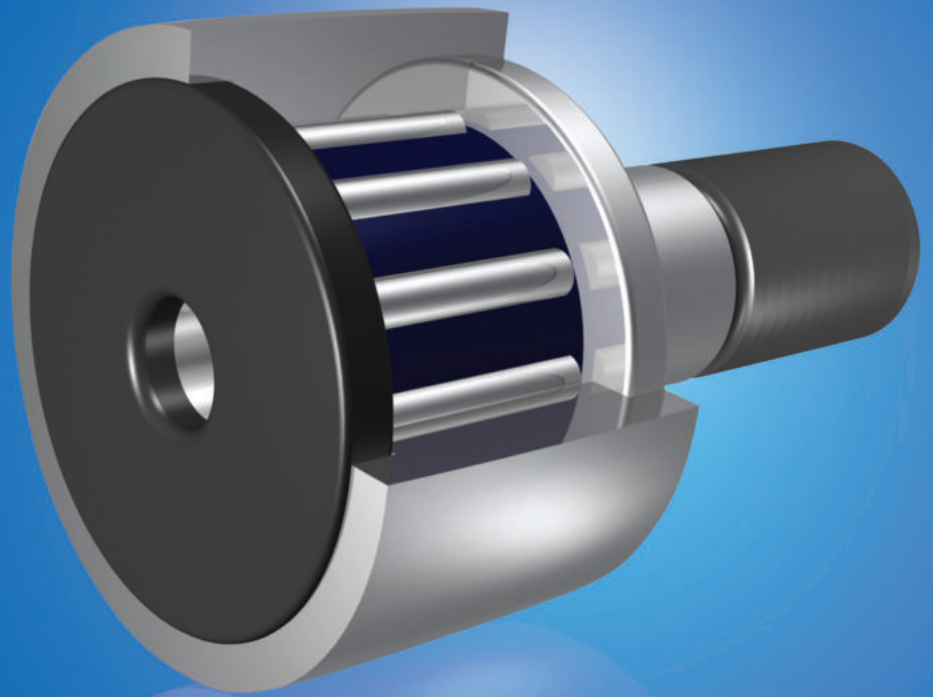

Galets de came





BEARINGS FOR YOUR FUTURE

Les roulements Zen sont fabriqués en accord avec les normes de qualité de plus haut niveau pour des applications standard et non standard. Notre service technique peut ajuster n'importe quel roulement non standard afin de l'adapter à vos nécessités, quelle qu'elle soit la quantité.

En plus de notre gamme de roulements miniature de plus de 1000 références, entre 1mm. et 10 mm., notre catalogue de produits contient aussi des roulements à section mince, des butées à billes, des roulements série populaire ainsi qu'un infinité de roulements non standard. Nous sommes en mesure de concevoir des roulements en concordance avec vos exigences en utilisant des nouveaux matériaux, tels que : céramiques ou aciers spéciaux pour différentes applications industrielles, médicales, chimiques ou de transformation alimentaire.

N'hésitez pas à contacter notre personnel commercial qualifié si jamais vous avez besoin d'une référence qui n'apparaît pas sur notre catalogue.



L'entreprise Zen Ball Bearings Shanghai a été gratifiée du certificat Aleman de qualité ISO TUV Rheinland pour l'inspection de ses propres produits Zen.

Ce certificat est l'une des plus hautes reconnaissances qu'une entreprise puisse atteindre dans notre secteur. Il s'agit d'un prix reconnu internationalement qui authentifie un haut niveau de qualité, orientation client et amélioration continue.

www.zen.biz

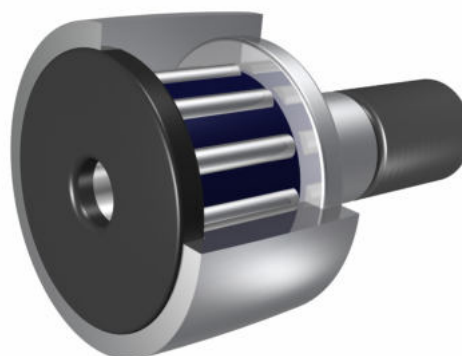

Galets de came

Galets de came

NA2200 - 2RS	3
NATR & NATV	4
NUTR	7
CYR	8

Galets de came avec axe

KR & NUKR	14
CF / CF...S	18
CF...B / CF...SB	22
CFE / CFE...S	26
CFE...B / CFE...SB	30
CCF...S / CCF...SB	34
CCFE...S / CCFE...SB	36
CFH / CFH...S	42
CFH...B / CFH...SB	46
CCFH...S / CCFH...SB	50



Geeignet für hohe tragzahlen*[^]
Suitable for heavy load rating*[^]



Ölschmierung*
Oil lubrication*



Fettschmierung*
Grease lubrication*



Gummidichtscheiben verfügbar*
Rubber seal option available*

Galets de came NA2200-2RS

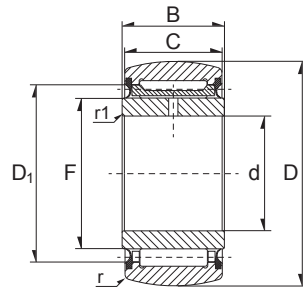
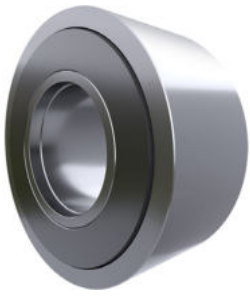

3

Dimension (mm)								Designation/Type	*Basic Load Rating		*Limiting Speed RPM	Mass (g) approx.
d	D	C	B	F	D ₁	r	r ₁		C, dyn. N	C ₀ Stat. N		
6.0	19.0	11.8	12.0	10.0	16.0	0.3	0.3	NA22/6-2RS	3900	3650	9000	22 g
8.0	24.0	11.8	12.0	12.0	18.0	0.3	0.3	NA22/8-2RS	4800	4800	7000	34 g
10.0	30.0	13.8	14.0	14.0	20.0	0.6	0.3	NA2200-2RS	7000	8000	5500	60 g
12.0	32.0	13.8	14.0	16.0	22.0	0.6	0.3	NA2201-2RS	7500	9000	4700	67 g
15.0	35.0	13.8	14.0	20.0	26.0	0.6	0.3	NA2202-2RS	7600	9500	3400	75 g
17.0	40.0	15.8	16.0	22.0	28.0	1.0	0.3	NA2203-2RS	9900	13700	3000	112 g
20.0	47.0	17.8	18.0	25.0	33.0	1.0	0.3	NA2204-2RS	1500	18300	2300	177 g
25.0	52.0	17.8	18.0	30.0	38.0	1.0	0.3	NA2205-2RS	15700	19900	1800	209 g
30.0	62.0	19.8	20.0	35.0	43.0	1.0	0.3	NA2206-2RS	18400	25500	1400	324 g
35.0	72.0	22.7	23.0	42.0	50.0	1.1	0.6	NA2207-2RS	23000	35500	1100	505 g
40.0	80.0	22.7	23.0	48.0	57.0	1.1	0.6	NA2208-2RS	27500	40500	850	628 g
50.0	90.0	22.7	23.0	58.0	68.0	1.1	0.6	NA2210-2RS	28000	42500	650	690 g

Galets de came NATR & NATV

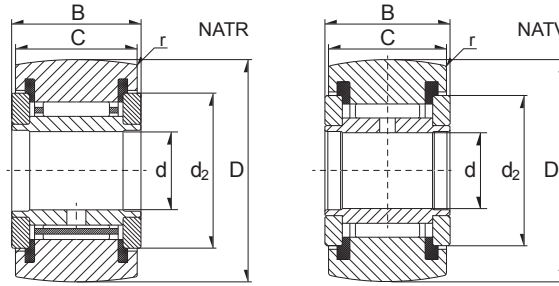
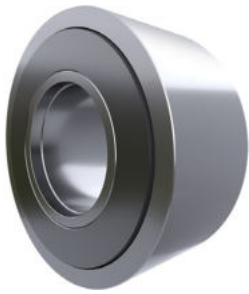

4

Dimension (mm)						Designation/Type	Load Rating		Fatigue Limit Load	*Limiting Speed RPM	Mass (g) approx.
d	D	B	C	d ₂	r		C ₀ Stat. N	C, dyn. N			
5.0	16.0	12.0	11.0	12.5	0.15	NATR 5	3150	3300	415	14000	14 g
5.0	16.0	12.0	11.0	12.5	0.15	NATV 5	4900	6500	860	3800	15 g
5.0	16.0	12.0	11.0	12.5	0.15	NATR 5-PP	3150	3300	415	14000	14 g
5.0	16.0	12.0	11.0	12.5	0.15	NATV 5-PP	4900	6500	860	3800	15 g
5.0	16.0	12.0	11.0	12.5	0.15	NATR 5-PPX	3150	3300	415	14000	14 g
5.0	16.0	12.0	11.0	12.5	0.15	NATV 5-PPX	4900	6500	860	3800	15 g
6.0	19.0	12.0	11.0	15.0	0.15	NATR 6	3500	3900	485	11000	20 g
6.0	19.0	12.0	11.0	15.0	0.15	NATV 6	5400	7900	1040	3100	21 g
6.0	19.0	12.0	11.0	15.0	0.15	NATR 6-PP	3500	3900	485	11000	19 g
6.0	19.0	12.0	11.0	15.0	0.15	NATV 6-PP	5400	7900	1040	3100	21 g
6.0	19.0	12.0	11.0	15.0	0.15	NATR 6-PPX	3500	3900	485	11000	19 g
6.0	19.0	12.0	11.0	15.0	0.15	NATV 6-PPX	5400	7900	1040	3100	21 g
8.0	24.0	15.0	14.0	19.0	0.3	NATR 8	5500	6400	810	7500	41 g
8.0	24.0	15.0	14.0	19.0	0.3	NATV 8	7800	11400	1430	2500	42 g
8.0	24.0	15.0	14.0	19.0	0.3	NATR 8-PP	5500	6400	810	7500	38 g
8.0	24.0	15.0	14.0	19.0	0.3	NATV 8-PP	7800	11400	1430	2500	41 g
8.0	24.0	15.0	14.0	19.0	0.3	NATR 8-PPX	5500	6400	810	7500	38 g
8.0	24.0	15.0	14.0	19.0	0.3	NATV 8-PPX	7800	11400	1430	2500	41 g
10.0	30.0	15.0	14.0	23.0	0.6	NATR 10	6800	8400	1070	5500	64 g
10.0	30.0	15.0	14.0	23.0	0.6	NATV 10	9500	14600	1840	2100	65 g
10.0	30.0	15.0	14.0	23.0	0.6	NATR 10-PP	6800	8400	1070	5500	61 g
10.0	30.0	15.0	14.0	23.0	0.6	NATV 10-PP	9500	14600	1840	2100	64 g
10.0	30.0	15.0	14.0	23.0	0.6	NATR 10-PPX	6800	8400	1070	5500	61 g
10.0	30.0	15.0	14.0	23.0	0.6	NATV 10-PPX	9500	14600	1840	2100	64 g
12.0	32.0	15.0	14.0	25.0	0.6	NATR 12	6900	8800	1720	4500	71 g
12.0	32.0	15.0	14.0	25.0	0.6	NATV 12	9700	15400	1950	1800	72 g
12.0	32.0	15.0	14.0	25.0	0.6	NATR 12-PP	6900	8800	1720	4500	66 g
12.0	32.0	15.0	14.0	25.0	0.6	NATV 12-PP	9700	15400	1950	1800	69 g
12.0	32.0	15.0	14.0	25.0	0.6	NATR 12-PPX	6900	8800	1720	4500	66 g
12.0	32.0	15.0	14.0	25.0	0.6	NATV 12-PPX	9700	15400	1950	1800	69 g

Galets de came NATR & NATV

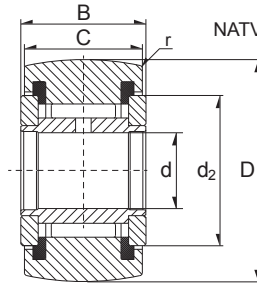
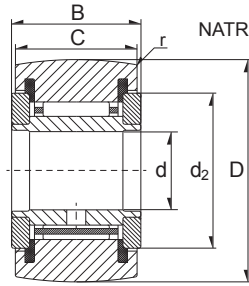
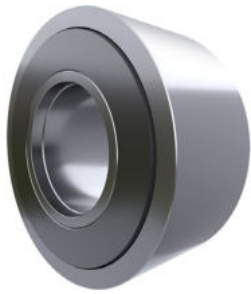

5

Dimension (mm)						Designation/Type	Load Rating		Fatigue Limit Load	*Limiting Speed RPM	Mass (g) approx.
d	D	B	C	d ₂	r		C ₀ Stat. N	C, dyn. N			
15.0	35.0	19.0	18.0	27.6	0.6	NATR 15	9800	14100	1700	3600	104 g
15.0	35.0	19.0	18.0	27.6	0.6	NATV 15	12800	23000	2900	1600	109 g
15.0	35.0	19.0	18.0	27.6	0.6	NATR 15-PP	9800	14100	1700	3600	95 g
15.0	35.0	19.0	18.0	27.6	0.6	NATV 15-PP	12800	23000	2900	1600	101 g
15.0	35.0	19.0	18.0	27.6	0.6	NATR 15-PPX	9800	14100	1700	3600	95 g
15.0	35.0	19.0	18.0	27.6	0.6	NATV 15-PPX	12800	23000	2900	1600	101 g
17.0	40.0	21.0	20.0	31.5	1.0	NATR 17	10900	15500	1850	2900	144 g
17.0	40.0	21.0	20.0	31.5	1.0	NATV 17	14800	26500	3050	1400	152 g
17.0	40.0	21.0	20.0	31.5	1.0	NATR 17-PP	10900	15500	1850	2900	139 g
17.0	40.0	21.0	20.0	31.5	1.0	NATV 17-PP	14800	26500	3050	1400	147 g
17.0	40.0	21.0	20.0	31.5	1.0	NATR 17-PPX	10900	15500	1850	2900	139 g
17.0	40.0	21.0	20.0	31.5	1.0	NATV 17-PPX	14800	26500	3050	1400	147 g
20.0	47.0	25.0	24.0	36.5	1.0	NATR 20	15500	25500	3000	2400	246 g
20.0	47.0	25.0	24.0	36.5	1.0	NATV 20	20600	42000	5200	1300	254 g
20.0	47.0	25.0	24.0	36.5	1.0	NATR 20-PP	15500	25500	3000	2400	236 g
20.0	47.0	25.0	24.0	36.5	1.0	NATV 20-PP	20600	42000	5200	1300	245 g
20.0	47.0	25.0	24.0	36.5	1.0	NATR 20-PPX	15500	25500	3000	2400	236 g
20.0	47.0	25.0	24.0	36.5	1.0	NATV 20-PPX	20600	42000	5200	1300	245 g
25.0	52.0	25.0	24.0	41.5	1.0	NATR 25	15400	26500	3010	1800	275 g
25.0	52.0	25.0	24.0	41.5	1.0	NATV 25	20500	44000	5400	1000	285 g
25.0	52.0	25.0	24.0	41.5	1.0	NATR 25-PP	15400	26500	3010	1800	271 g
25.0	52.0	25.0	24.0	41.5	1.0	NATV 25-PP	20500	44000	5400	1000	281 g
25.0	52.0	25.0	24.0	41.5	1.0	NATR 25-PPX	15400	26500	3010	1800	271 g
25.0	52.0	25.0	24.0	41.5	1.0	NATV 25-PPX	20500	44000	5400	1000	281 g
30.0	62.0	29.0	28.0	51.0	1.0	NATR 30	23400	38500	4650	1300	470 g
30.0	62.0	29.0	28.0	51.0	1.0	NATV 30	30500	62000	7800	850	481 g
30.0	62.0	29.0	28.0	51.0	1.0	NATR 30-PP	23400	38500	4650	1300	444 g
30.0	62.0	29.0	28.0	51.0	1.0	NATV 30-PP	30500	62000	7800	850	468 g
30.0	62.0	29.0	28.0	51.0	1.0	NATR 30-PPX	23400	38500	4650	1300	444 g
30.0	62.0	29.0	28.0	51.0	1.0	NATV 30-PPX	30500	62000	7800	850	468 g

Galets de came NATR & NATV

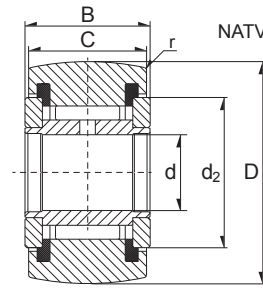
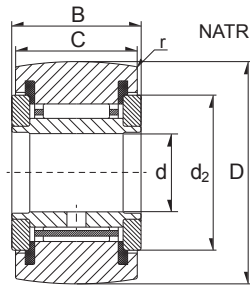
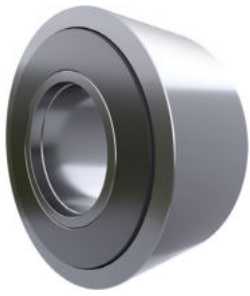

6

Dimension (mm)						Designation/Type	Load Rating		Fatigue Limit Load	*Limiting Speed RPM	Mass (g) approx.
d	D	B	C	d ₂	r		C ₀ Stat. N	C, dyn. N			
35.0	72.0	29.0	28.0	58.0	1.1	NATR 35-PP	25000	44000	5300	1000	547 g
35.0	72.0	29.0	28.0	58.0	1.1	NATV 35-PP	33000	71000	8900	750	630 g
35.0	72.0	29.0	28.0	58.0	1.1	NATR 35-PPX	25000	44000	5300	1000	547 g
35.0	72.0	29.0	28.0	58.0	1.1	NATV 35-PPX	33000	71000	8900	750	630 g
40.0	80.0	32.0	30.0	66.0	1.1	NATR 40-PP	32500	58000	7000	850	795 g
40.0	80.0	32.0	30.0	66.0	1.1	NATV 40-PP	41000	88000	11000	650	832 g
40.0	80.0	32.0	30.0	66.0	1.1	NATR 40-PPX	32500	58000	7000	850	795 g
40.0	80.0	32.0	30.0	66.0	1.1	NATV 40-PPX	41000	88000	11000	650	832 g
50.0	90.0	32.0	30.0	76.0	1.1	NATR 50-PP	31500	59000	7100	650	867 g
50.0	90.0	32.0	30.0	76.0	1.1	NATV 50-PP	40000	92000	11600	550	969 g
50.0	90.0	32.0	30.0	76.0	1.1	NATR 50-PPX	31500	59000	7100	650	867 g
50.0	90.0	32.0	30.0	76.0	1.1	NATV 50-PPX	40000	92000	11600	550	969 g

Galets de came NUTR

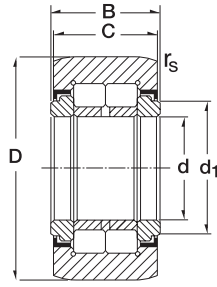
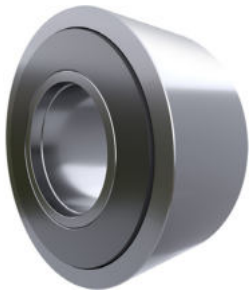

7

Dimension (mm)						Designation/Type	*Basic Load Rating		*Limiting Speed x1000rpm Grease	Mass (g) approx.
d	D	B	C	r _s	d _{1min}		C, dyn. N	C ₀ Stat. N		
15.0	35.0	19.0	18.0	0.6	20.0	NUTR 15	23000	27000	6.5	99 g
17.0	40.0	21.0	20.0	1.0	22.0	NUTR 17	24800	31000	5.5	147 g
15.0	42.0	19.0	18.0	0.6	20.0	NUTR 15 42	23000	27000	6.5	158 g
17.0	47.0	21.0	20.0	1.0	22.0	NUTR 17 47	24800	31000	5.5	220 g
20.0	47.0	25.0	24.0	1.0	27.0	NUTR 20	39000	50000	4.2	245 g
20.0	52.0	25.0	24.0	1.0	27.0	NUTR 20 52	39000	50000	4.2	321 g
25.0	52.0	25.0	24.0	1.0	31.0	NUTR 25	43500	60000	3.4	281 g
25.0	62.0	25.0	24.0	1.0	31.0	NUTR 25 62	43500	60000	3.4	450 g
30.0	62.0	29.0	28.0	1.0	38.0	NUTR 30	59000	79000	2.6	465 g
30.0	72.0	29.0	28.0	1.0	38.0	NUTR 30 72	59000	79000	2.6	697 g
35.0	72.0	29.0	28.0	1.1	44.0	NUTR 35	65000	93000	2.1	630 g
35.0	80.0	29.0	28.0	1.1	44.0	NUTR 35 80	65000	93000	2.1	836 g
40.0	80.0	32.0	30.0	1.1	51.0	NUTR 40	90000	134000	1.6	816 g
45.0	85.0	32.0	30.0	1.1	55.0	NUTR 45	95000	147000	1.4	883 g
40.0	90.0	32.0	30.0	1.1	51.0	NUTR 40 90	90000	134000	1.6	1129 g
50.0	90.0	32.0	30.0	1.1	60.0	NUTR 50	100000	161000	1.3	950 g
45.0	100.0	32.0	30.0	1.1	55.0	NUTR 45 100	95000	147000	1.4	1396 g
50.0	110.0	32.0	30.0	1.1	60.0	NUTR 50 110	100000	161000	1.3	1690 g

Alle Referenzen können mit zylindrischen Aussenring geliefert werden
 All references can be supplied with cylindrical outer ring

Galets de came CYR

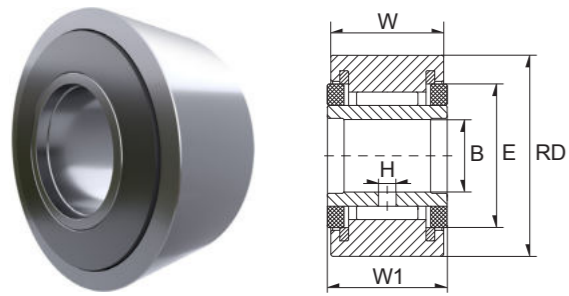

8

Dimension (inch)					
RD	W	B	W1	E	H
0,750	0,500	0,250	0,5625	39/64	3/32
0,750	0,500	0,250	0,5625	39/64	3/32
0,750	0,500	0,250	0,5625	39/64	3/32
0,875	0,500	0,250	0,5625	39/64	3/32
0,875	0,500	0,250	0,5625	39/64	3/32
0,875	0,500	0,250	0,5625	39/64	3/32
1,000	0,625	0,3125	0,6875	25/32	3/32
1,125	0,625	0,3125	0,6875	25/32	3/32
1,125	0,625	0,3125	0,6875	25/32	3/32
1,125	0,625	0,3125	0,6875	25/32	3/32
1,000	0,625	0,3125	0,6875	25/32	3/32
1,000	0,625	0,3125	0,6875	25/32	3/32
1,250	0,750	0,375	0,8125	63/64	3/32
1,250	0,750	0,375	0,8125	63/64	3/32
1,250	0,750	0,375	0,8125	63/64	3/32
1,375	0,750	0,375	0,8125	63/64	3/32
1,375	0,750	0,375	0,8125	63/64	3/32
1,375	0,750	0,375	0,8125	63/64	3/32
1,500	0,875	0,4375	0,9375	1 3/32	3/32
1,500	0,875	0,4375	0,9375	1 3/32	3/32
1,500	0,875	0,4375	0,9375	1 3/32	3/32
1,625	0,875	0,4375	0,9375	1 3/32	3/32
1,625	0,875	0,4375	0,9375	1 3/32	3/32
1,625	0,875	0,4375	0,9375	1 3/32	3/32
1,750	1,000	0,500	1,0625	1 1/4	3/32
1,750	1,000	0,500	1,0625	1 1/4	3/32
1,750	1,000	0,500	1,0625	1 1/4	3/32
1,875	1,000	0,500	1,0625	1 1/4	3/32
1,875	1,000	0,500	1,0625	1 1/4	3/32
1,875	1,000	0,500	1,0625	1 1/4	3/32



9

Designation/Type					Load Rating		Weight (kg) approx.
TORRINGTON	RBC	ZEN	SMITH	INA	Static (lbs)	Dynamic (lbs)	
YCR-12	Y-24	CYR-3/4	YR-3/4	RF-12	4130	1660	0.03 kg
YCRS-12	Y-24-L	CYR-3/4-S	YR-3/4X	RF-12-PP	4130	1660	0.03 kg
YCRSC-12	CY-24-L	CCYR-3/4-S	YR-3/4XC	-	4130	1660	0.03 kg
YCR-14	Y-28	CYR-7/8	YR-7/8	RF-14	4130	1660	0.04 kg
YCRS-14	Y-28-L	CYR-7/8-S	YR-7/8X	RF-14-PP	4130	1660	0.04 kg
YCRSC-14	CY-28-L	CCYR-7/8-S	YR-7/8XC	-	4130	1660	0.04 kg
YCR-16	Y-32	CYR-1	YR-1	RF-16	6120	2225	0.07 kg
YCR-18	Y-36	CYR-1 1/8	YR-1 1/8	RF-18	6120	2225	0.08 kg
YCRS-18	Y-36-L	CYR-1 1/8-S	YR-1 1/8X	RF-18-PP	6120	2225	0.08 kg
YCRSC-18	CY-36-L	CCYR-1 1/8-S	YR-1 1/8XC	-	6120	2225	0.08 kg
YCRS-16	Y-32-L	CYR-1-S	YR-1X	RF-16-PP	6120	2225	0.07 kg
YCRSC-16	CY-32-L	CCYR-1-S	YR-1XC	-	6120	2225	0.07 kg
YCR-20	Y-40	CYR-1 1/4	YR-1 1/4	RF-20	8500	3930	0.11 kg
YCRS-20	Y-40-L	CYR-1 1/4-S	YR-1 1/4X	RF-20-PP	8500	3930	0.11 kg
YCRSC-20	CY-40-L	CCYR-1 1/4-S	YR-1 1/4XC	-	8500	3930	0.11 kg
YCR-22	Y-44	CYR-1 3/8	YR-1 3/8	RF-22	8500	3930	0.14 kg
YCRS-22	Y-44-L	CYR-1 3/8-S	YR-1 3/8X	RF-22-PP	8500	3930	0.14 kg
YCRSC-22	CY-44-L	CCYR-1 3/8-S	YR-1 3/8XC	-	8500	3930	0.14 kg
YCR-24	Y-48	CYR-1 1/2	YR-1 1/2	RF-24	11280	4840	0.19 kg
YCRS-24	Y-48-L	CYR-1 1/2-S	YR-1 1/2X	RF-24-PP	11280	4840	0.19 kg
YCRSC-24	CY-48-L	CCYR-1 1/2-S	YR-1 1/2XC	-	11280	4840	0.19 kg
YCR-26	Y-52	CYR-1 5/8	YR-1 5/8	RF-26	11280	4840	0.23 kg
YCRS-26	Y-52-L	CYR-1 5/8-S	YR-1 5/8X	RF-26-PP	11280	4840	0.23 kg
YCRSC-26	CY-52-L	CCYR-1 5/8-S	YR-1 5/8XC	-	11280	4840	0.23 kg
YCR-28	Y-56	CYR-1 3/4	YR-1 3/4	RF-28	15840	6385	0.29 kg
YCRS-28	Y-56-L	CYR-1 3/4-S	YR-1 3/4X	RF-28-PP	15840	6385	0.29 kg
YCRSC-28	CY-56-L	CCYR-1 3/4-S	YR-1 3/4XC	-	15840	6385	0.29 kg
YCR-30	Y-60	CYR-1 7/8	YR-1 7/8	RF-30	15840	6385	0.36 kg
YCRS-30	Y-60-L	CYR-1 7/8-S	YR-1 7/8X	RF-30-PP	15840	6385	0.36 kg
YCRSC-30	CY-60-L	CCYR-1 7/8-S	YR-1 7/8XC	-	15840	6385	0.36 kg

Galets de came CYR

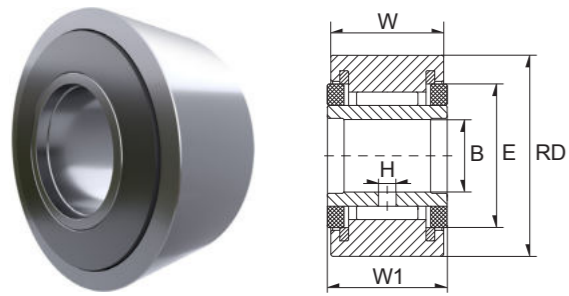

10

Dimension (mm)					
RD	W	B	W1	E	H
2,000	1,250	0,625	1,3125	1 13/32	3/32
2,250	1,250	0,625	1,3125	1 13/32	1/8
2,250	1,250	0,625	1,3125	1 13/32	1/8
2,250	1,250	0,625	1,3125	1 13/32	1/8
2,000	1,250	0,625	1,3125	1 13/32	3/32
2,000	1,250	0,625	1,3125	1 13/32	3/32
2,500	1,500	0,750	1,5625	1 11/16	1/8
2,500	1,500	0,750	1,5625	1 11/16	1/8
2,500	1,500	0,750	1,5625	1 11/16	1/8
2,750	1,500	0,750	1,5625	1 11/16	1/8
2,750	1,500	0,750	1,5625	1 11/16	1/8
2,750	1,500	0,750	1,5625	1 11/16	1/8
3,000	1,750	1,000	1,8125	2 1/8	1/8
3,250	1,750	1,000	1,8125	2 1/8	1/8
3,250	1,750	1,000	1,8125	2 1/8	1/8
3,250	1,750	1,000	1,8125	2 1/8	1/8
3,000	1,750	1,000	1,8125	2 1/8	1/8
3,000	1,750	1,000	1,8125	2 1/8	1/8
3,500	2,000	1,125	2,0625	2 7/16	1/8
3,500	2,000	1,125	2,0625	2 7/16	1/8
3,500	2,000	1,125	2,0625	2 7/16	1/8
4,000	2,250	1,250	2,3125	2 51/64	1/8
4,000	2,250	1,250	2,3125	2 51/64	1/8
4,000	2,250	1,250	2,3125	2 51/64	1/8
5,000	2,750	1,750	2,8750	3 9/16	3/16
5,000	2,750	1,750	2,8750	3 9/16	3/16
6,000	3,250	2,250	3,3750	4 15/32	3/16
6,000	3,250	2,250	3,3750	4 15/32	3/16
7,000	3,750	2,750	3,8750	5 3/16	3/16
7,000	3,750	2,750	3,8750	5 3/16	3/16



11

Designation/Type					Load Rating		Weight (kg) approx.
TORRINGTON	RBC	ZEN	SMITH	INA	Static (lbs)	Dynamic (lbs)	
YCR-32	Y-64	CYR-2	YR-2	RF-32	21140	8090	0.48 kg
YCR-36	Y-72	CYR-2 1/4	YR-2 1/4	RF-36	21140	8090	0.60 kg
YCRS-36	Y-72-L	CYR-2 1/4-S	YR-2 1/4X	RF-36-PP	21140	8090	0.60 kg
YCRSC-36	CY-72-L	CCYR-2 1/4-S	YR-2 1/4XC	-	21140	8090	0.60 kg
YCRS-32	Y-64-L	CYR-2-S	YR-2X	RF-32-PP	21140	8090	0.48 kg
YCRSC-32	CY-64-L	CCYR-2-S	YR-2XC	-	21140	8090	0.48 kg
YCR-40	Y-80	CYR-2 1/2	YR-2 1/2	RF-40	32900	11720	0.82 kg
YCRS-40	Y-80-L	CYR-2 1/2-S	YR-2 1/2X	RF-40-PP	32900	11720	0.82 kg
YCRSC-40	CY-80-L	CCYR-2 1/2-S	YR-2 1/2XC	-	32900	11720	0.82 kg
YCR-44	Y-88	CYR-2 3/4	YR-2 3/4	RF-44	32900	11720	1.02 kg
YCRS-44	Y-88-L	CYR-2 3/4-S	YR-2 3/4X	RF-44-PP	32900	11720	1.02 kg
YCRSC-44	CY-88-L	CCYR-2 3/4-S	YR-2 3/4XC	-	32900	11720	1.02 kg
YCR-48	Y-96	CYR-3	YR-3	RF-48	49820	15720	1.41 kg
YCR-52	Y-104	CYR-3 1/4	YR-3 1/4	RF-52	49820	15720	1.64 kg
YCRS-52	Y-104-L	CYR-3 1/4-S	YR-3 1/4X	RF-52-PP	49820	15720	1.64 kg
YCRSC-52	CY-104-L	CCYR-3 1/4-S	YR-3 1/4XC	-	49820	15720	1.64 kg
YCRS-48	Y-96-L	CYR-3-S	YR-3X	RF-48-PP	49820	15720	1.41 kg
YCRSC-48	CY-96-L	CCYR-3-S	YR-3XC	-	49820	15720	1.41 kg
YCR-56	Y-112	CYR-3 1/2	YR-3 1/2	RF-56	63250	22800	2.25 kg
YCRS-56	Y-112-L	CYR-3 1/2-S	YR-3 1/2X	RF-56-PP	63250	22800	2.25 kg
YCRSC-56	CY-112-L	CCYR-3 1/2-S	YR-3 1/2XC	-	63250	22800	2.25 kg
YCR-64	Y-128	CYR-4	YR-4	RF-64	89540	29985	3.20 kg
YCRS-64	Y-128-L	CYR-4-S	YR-4X	RF-64-PP	89540	29985	3.20 kg
YCRSC-64	CY-128-L	CCYR-4-S	YR-4XC	-	89540	29985	0.48 kg
YCRS-80	Y-160-L	CYR-5-S	YR-5X	-	135900	46575	6.50 kg
YCRSC-80	CY-160-L	CCYR-5-S	YR-5XC	-	135900	46575	6.50 kg
YCRS-96	Y-192-L	CYR-6-S	YR-6X	-	160900	60000	9.14 kg
YCRSC-96	CY-192-L	CCYR-6-S	YR-6XC	-	160900	60000	9.14 kg
YCRS-112	Y-224-L	CYR-7-S	-	-	213860	75380	14.71 kg
YCRSC-112	CY-224-L	CCYR-7-S	-	-	213860	75380	14.71 kg

Galets de came CYR

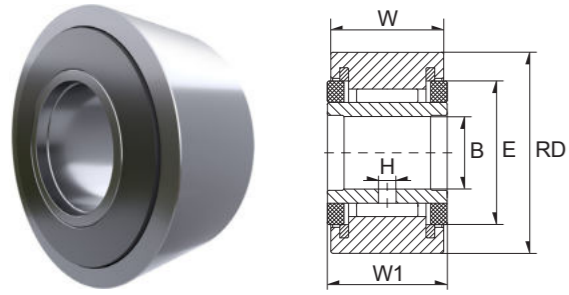

12

Dimension (mm)					
RD	W	B	W1	E	H
8,000	4,250	3,255	4,500	4 3/8	1/4
8,000	4,250	3,255	4,500	4 3/8	1/4
9,000	4,750	3,755	5,000	5 1/16	5/16
9,000	4,750	3,755	5,000	5 1/16	5/16
10,000	5,250	4,255	5,500	5 15/32	3/8
10,000	5,250	4,255	5,500	5 15/32	3/8



13

Designation/Type					Load Rating		Weight (kg) approx.
TORRINGTON	RBC	ZEN	SMITH	INA	Static (lbs)	Dynamic (lbs)	
-	-	CYR-8-S	-	-	288200	92200	21.45 kg
-	-	CCYR-8-S	-	-	288200	92200	21.45 kg
-	-	CYR-9-S	-	-	366850	113260	29.80 kg
-	-	CCYR-9-S	-	-	366850	113260	29.80 kg
-	-	CYR-10-S	-	-	431130	131545	40.46 kg
-	-	CCYR-10-S	-	-	431130	131545	40.46 kg

Galets de came avec axe KR & NUKR

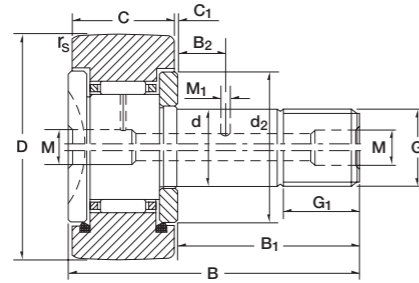
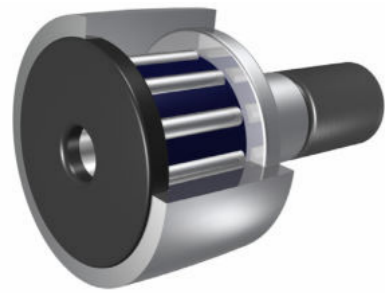

16

Dimensions (mm)				Outside Diameter (mm)	Designation /Type	Weight (g) approx.	With Eccentric Collar	Weight (g) approx.	Dimensions (mm)				
d	D	B	C						rs min	B1	B2	G	G1
18.0	40.0	58.0	20.0	40.0	KR 40PP	247 g	KRE 40PP	263 g	1	36.5	8	M18X1.5	19
18.0	40.0	58.0	20.0	40.0	KRV 40	249 g	KRVE 40	265 g	1	36.5	8	M18X1.5	19
18.0	40.0	58.0	20.0	40.0	KRV 40PP	249 g	KRVE 40PP	265 g	1	36.5	8	M18X1.5	19
18.0	40.0	58.0	20.0	40.0	NUKR 40	242 g	NUKRE 40	258 g	1	36.5 ⁽⁴⁾	8	M18X1.5	19
20.0	47.0	66.0	24.0	47.0	NUKR 47	380 g	NUKRE 47	400 g	1	40.5	9	-	21
24.0	72.0	80.0	28.0	72.0	NUKR 72	1020 g	NUKRE 72	1050 g	1	49.5	11	-	25

The suffix 'X' indicates a cylindrical outside surface, e.g. KR16X.

The basic load ratings 'C' and 'Cow' apply if the bearing out ring (with cylindrical outside surface) is mounted in a housing bore. When used as a track roller, the load ratings Cw and Cow apply

For oil lubrication, the speed can be increased by approximately 30%, except for sealed executions

NUKRE 35 B=31.5; C=1.8; D=24
NUKRE 40 B=35.5; C=1.8; D=26"

Lubrication hole is in the end face at the ribbed end of the stud only.



17

Dimensions (mm)							Nut Tightening Torque Ma Nm	Basic Load Ratings						Limiting Speed x1000 rpm
M	M1	C1	D	Eccentric Collar				Stud Type Track Roller						
				h9	B1	e		C N	Co N	Cw N	Cow N	Fr perm	For perm	
6	3	0.8	32	22	16	1	87	14200	20400	10900	15500	-	-	6.0
6	3	0.8	32	22	16	1	87	21000	39500	14800	26500	-	-	2.9
6	3	0.8	32	22	16	1	87	21000	39500	14800	26500	-	-	2.9
6	3	0.8 ⁽⁴⁾	23 ⁽⁴⁾	22	16	1	87	24800	31000	18500	22800	13200	22800	5.5
6	4	0.8	27	24	18	1	120	28500	37500	19900	26000	16200	32500	4.2
8	4	1.3	44	28	22	1	220	45000	65000	31500	45500	31500	63000	2.6

Galets de came avec axe CF & CF...S

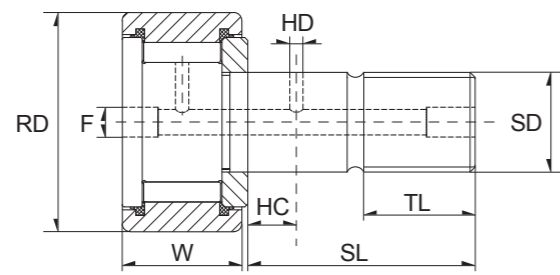
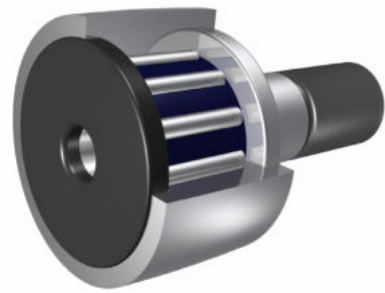

Dimension (inch)								
RD	W	SD	SL	TL	FINE THR'DS	HC	HD	F
0,500	0,375	0,190	5/8	1/4	10-32	-	-	1/8
0,500	0,344	0,190	1/2	1/4	10-32	-	-	1/8
0,500	0,344	0,190	1/2	1/4	10-32	-	-	1/8
0,500	0,375	0,190	5/8	1/4	10-32	-	-	1/8
0,5625	0,375	0,190	5/8	1/4	10-32	-	-	1/8
0,5625	0,375	0,190	5/8	1/4	10-32	-	-	1/8
0,625	0,4375	0,250	3/4	5/16	1/4-28	-	-	1/8
0,625	0,406	0,250	5/8	5/16	1/4-28	-	-	1/8
0,625	0,406	0,250	5/8	5/16	1/4-28	-	-	1/8
0,625	0,4375	0,250	3/4	5/16	1/4-28	-	-	1/8
0,6875	0,4375	0,250	3/4	5/16	1/4-28	-	-	1/8
0,6875	0,4375	0,250	3/4	5/16	1/4-28	-	-	1/8
0,750	0,500	0,375	7/8	3/8	3/8-24	1/4	3/32	3/16
0,750	0,500	0,375	7/8	3/8	3/8-24	1/4	3/32	3/16
0,875	0,500	0,375	7/8	3/8	3/8-24	1/4	3/32	3/16
0,875	0,500	0,375	7/8	3/8	3/8-24	1/4	3/32	3/16
1,000	0,625	0,4375	1	1/2	7/16-20	1/4	3/32	3/16
1,000	0,625	0,4375	1	1/2	7/16-20	1/4	3/32	3/16
1,125	0,625	0,4375	1	1/2	7/16-20	1/4	3/32	3/16
1,125	0,625	0,4375	1	1/2	7/16-20	1/4	3/32	3/16
1,250	0,750	0,500	1 1/4	5/8	1/2-20	5/16	3/32	3/16
1,250	0,750	0,500	1 1/4	5/8	1/2-20	5/16	3/32	3/16
1,375	0,750	0,500	1 1/4	5/8	1/2-20	5/16	3/32	3/16
1,375	0,750	0,500	1 1/4	5/8	1/2-20	5/16	3/32	3/16
1,500	0,875	0,625	1 1/2	3/4	5/8-18	3/8	3/32	3/16
1,500	0,875	0,625	1 1/2	3/4	5/8-18	3/8	3/32	3/16
1,625	0,875	0,625	1 1/2	3/4	5/8-18	3/8	3/32	3/16
1,625	0,875	0,625	1 1/2	3/4	5/8-18	3/8	3/32	3/16
1,750	1,000	0,750	1 3/4	7/8	3/4-16	7/16	3/32	3/16
1,750	1,000	0,750	1 3/4	7/8	3/4-16	7/16	3/32	3/16



Designation/Type				Recom. clamping torque (lbs-inch)	Load Rating Static (lbs)	Load Rating Dynamic (lbs)	Weight (kg) approx.
TORRINGTON	RBC	ZEN	SMITH				
CR-8-1	S-16	CF-1/2	CR-1/2	15	790	680	0.02 kg
CR-8	-	CF-1/2-N	CR-1/2-A	15	720	620	0.02 kg
CRS-8	-	CF-1/2-N-S	CR-1/2-AX	15	720	620	0.02 kg
CRS-8-1	S-16-L	CF-1/2-S	CR-1/2X	15	790	680	0.02 kg
-	S-18	CF-9/16	CR-9/16	15	790	680	0.02 kg
-	S-18-L	CF-9/16-S	CR-9/16X	15	790	680	0.02 kg
CR-10-1	S-20	CF-5/8	CR-5/8	35	1215	955	0.02 kg
CR-10	-	CF-5/8-N	CR-5/8-A	35	1085	930	0.02 kg
CRS-10	-	CF-5/8-N-S	CR-5/8-AX	35	1085	930	0.02 kg
CRS-10-1	S-20-L	CF-5/8-S	CR-5/8X	35	1215	955	0.02 kg
-	S-22	CF-11/16	CR-11/16	35	1215	955	0.03 kg
-	S-22-L	CF-11/16-S	CR-11/16X	35	1215	955	0.03 kg
CR-12	S-24	CF-3/4	CR-3/4	95	2065	1660	0.03 kg
CRS-12	S-24-L	CF-3/4-S	CR-3/4X	95	2065	1660	0.03 kg
CR-14	S-28	CF-7/8	CR-7/8	95	2065	1660	0.04 kg
CRS-14	S-28-L	CF-7/8-S	CR-7/8X	95	2065	1660	0.04 kg
CR-16	S-32	CF-1	CR-1	250	3060	2225	0.08 kg
CRS-16	S-32-L	CF-1-S	CR-1X	250	3060	2225	0.08 kg
CR-18	S-36	CF-1 1/8	CR-1 1/8	250	3060	2225	0.09 kg
CRS-18	S-36-L	CF-1 1/8-S	CR-1 1/8X	250	3060	2225	0.09 kg
CR-20	S-40	CF-1 1/4	CR-1 1/4	350	4250	3930	0.14 kg
CRS-20	S-40-L	CF-1 1/4-S	CR-1 1/4X	350	4250	3930	0.14 kg
CR-22	S-44	CF-1 3/8	CR-1 3/8	350	4250	3930	0.16 kg
CRS-22	S-44-L	CF-1 3/8-S	CR-1 3/8X	350	4250	3930	0.16 kg
CR-24	S-48	CF-1 1/2	CR-1 1/2	650	5640	4840	0.24 kg
CRS-24	S-48-L	CF-1 1/2-S	CR-1 1/2X	650	5640	4840	0.24 kg
CR-26	S-52	CF-1 5/8	CR-1 5/8	650	5640	4840	0.27 kg
CRS-26	S-52-L	CF-1 5/8-S	CR-1 5/8X	650	5640	4840	0.27 kg
CR-28	S-56	CF-1 3/4	CR-1 3/4	1250	7920	6385	0.38 kg
CRS-28	S-56-L	CF-1 3/4-S	CR-1 3/4X	1250	7920	6385	0.38 kg

Galets de came avec axe CF & CF...S

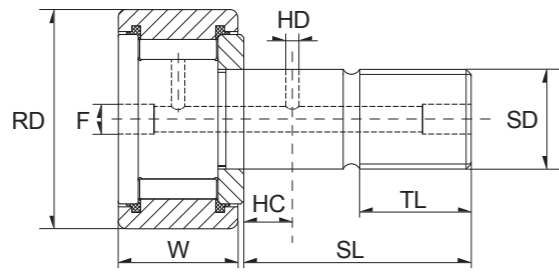
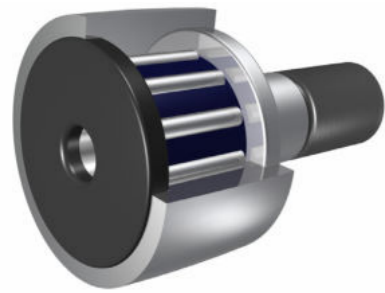

Dimension (inch)								
RD	W	SD	SL	TL	FINE THR'DS	HC	HD	F
1,875	1,000	0,750	1 3/4	7/8	3/4-16	7/16	3/32	3/16
1,875	1,000	0,750	1 3/4	7/8	3/4-16	7/16	3/32	3/16
2,000	1,250	0,875	2	1	7/8-14	1/2	1/8	3/16
2,000	1,250	0,875	2	1	7/8-14	1/2	1/8	3/16
2,250	1,250	0,875	2	1	7/8-14	1/2	1/8	3/16
2,250	1,250	0,875	2	1	7/8-14	1/2	1/8	3/16
2,500	1,500	1,000	2 1/4	1 1/8	1-14	9/16	1/8	3/16
2,500	1,500	1,000	2 1/4	1 1/8	1-14	9/16	1/8	3/16
2,750	1,500	1,000	2 1/4	1 1/8	1-14	9/16	1/8	3/16
2,750	1,500	1,000	2 1/4	1 1/8	1-14	9/16	1/8	3/16
3,000	1,750	1,250	2 1/2	1 1/4	1 1/4-12	5/8	1/8	1/4
3,000	1,750	1,250	2 1/2	1 1/4	1 1/4-12	5/8	1/8	1/4
3,250	1,750	1,250	2 1/2	1 1/4	1 1/4-12	5/8	1/8	1/4
3,250	1,750	1,250	2 1/2	1 1/4	1 1/4-12	5/8	1/8	1/4
3,500	2,000	1,75	2 3/4	1 3/8	1 3/8-12	11/16	1/8	1/4
3,500	2,000	1,75	2 3/4	1 3/8	1 3/8-12	11/16	1/8	1/4
4,000	2,250	1,500	3 1/2	1 1/2	1 1/2-12	3/4	1/8	1/4
4,000	2,250	1,500	3 1/2	1 1/2	1 1/2-12	3/4	1/8	1/4
5,000	2,750	2,000	5 1/16	2 9/16	2-12	7/8	3/16	1/4
6,000	3,250	2,500	6	3	2 1/2-12	1	3/16	1/4
7,000	3,750	3,000	7 11/16	4 1/8	3-12	1 1/4	3/16	1/4
8,000	4,250	3,250	8 1/2	4 1/4	3 1/4-4	-	-	1/4
9,000	4,750	3,750	9 1/2	4 3/4	3 1/2-4	-	-	1/4
10,000	5,250	4,250	10	4 3/4	3 1/2-4	-	-	1/4



Designation/Type				Recom. clamping torque (lbs-inch)	Load Rating Static (lbs)	Load Rating Dynamic (lbs)	Weight (kg) approx.
TORRINGTON	RBC	ZEN	SMITH				
CR-30	S-60	CF-1 7/8	CR-1 7/8	1250	7920	6385	0.43 kg
CRS-30	S-60-L	CF-1 7/8-S	CR-1 7/8X	1250	7920	6385	0.43 kg
CR-32	S-64	CF-2	CR-2	1500	10570	8090	0.62 kg
CRS-32	S-64-L	CF-2-S	CR-2X	1500	10570	8090	0.62 kg
CR-36	S-72	CF-2 1/4	CR-2 1/4	1500	10570	8090	0.75 kg
CRS-36	S-72-L	CF-2 1/4-S	CR-2 1/4X	1500	10570	8090	0.75 kg
CR-40	S-80	CF-2 1/2	CR-2 1/2	2250	16450	11720	1.13 kg
CRS-40	S-80-L	CF-2 1/2-S	CR-2 1/2X	2250	16450	11720	1.13 kg
CR-44	S-88	CF-2 3/4	CR-2 3/4	2250	16450	11720	1.33 kg
CRS-44	S-88-L	CF-2 3/4-S	CR-2 3/4X	2250	16450	11720	1.33 kg
CR-48	S-96	CF-3	CR-3	3450	24910	15720	1.91 kg
CRS-48	S-96-L	CF-3-S	CR-3X	3450	24910	15720	1.91 kg
CR-52	S-104	CF-3 1/4	CR-3 1/4	3450	24910	15720	2.18 kg
CRS-52	S-104-L	CF-3 1/4-S	CR-3 1/4X	3450	24910	15720	2.18 kg
CR-56	S-112	CF-3 1/2	CR-3 1/2	4200	31625	22800	2.91 kg
CRS-56	S-112-L	CF-3 1/2-S	CR-3 1/2X	4200	31625	22800	2.91 kg
CR-64	S-128	CF- 4	CR-4	5000	44770	29985	4.29 kg
CRS-64	S-128-L	CF- 4-S	CR-4X	5000	44770	29985	4.29 kg
-	-	CF-5-S	CR-5X	5000	67950	46575	8.85 kg
-	-	CF-6-S	CR-6X	5000	80450	60000	14.85 kg
-	-	CF-7-S	CR-7X	5000	106930	75380	24.83 kg
-	-	CF-8-S	CR8X	5000	144100	92200	36.20 kg
-	-	CF-9-S	CR-9X	5000	183430	113260	50.65 kg
-	-	CF-10-S	CR-10X	5000	215565	131545	67.22 kg

Galets de came avec axe CF...B & CF...SB

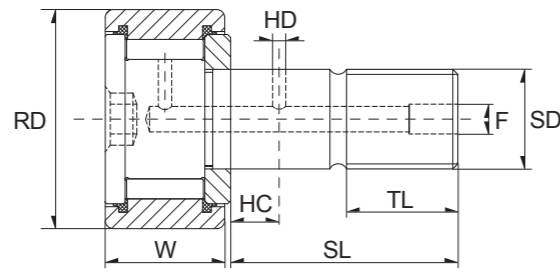
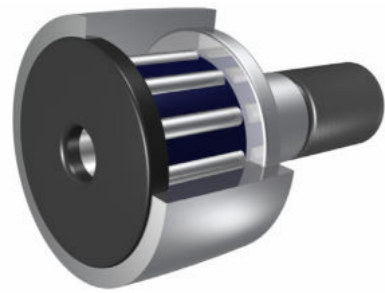

Dimension (inch)								
RD	W	SD	SL	TL	FINE THR'DS	HC	HD	F
0,500	0,344	0,190	1/2	1/4	10-32	-	-	-
0,500	0,375	0,190	5/8	1/4	10-32	-	-	-
0,500	0,344	0,190	1/2	1/4	10-32	-	-	-
0,500	0,375	0,190	5/8	1/4	10-32	-	-	-
0,5625	0,375	0,190	5/8	1/4	10-32	-	-	-
0,5625	0,375	0,190	5/8	1/4	10-32	-	-	-
0,625	0,406	0,250	5/8	5/16	1/4-28	-	-	-
0,625	0,4375	0,250	3/4	5/16	1/4-28	-	-	-
0,625	0,406	0,250	5/8	5/16	1/4-28	-	-	-
0,625	0,4375	0,250	3/4	5/16	1/4-28	-	-	-
0,6875	0,4375	0,250	3/4	5/16	1/4-28	-	-	-
0,6875	0,4375	0,250	3/4	5/16	1/4-28	-	-	-
0,750	0,500	0,375	7/8	3/8	3/8-24	1/4	3/32	3/16
0,750	0,500	0,375	7/8	3/8	3/8-24	1/4	3/32	3/16
0,875	0,500	0,375	7/8	3/8	3/8-24	1/4	3/32	3/16
0,875	0,500	0,375	7/8	3/8	3/8-24	1/4	3/32	3/16
1,000	0,625	0,4375	1	1/2	7/16-20	1/4	3/32	3/16
1,000	0,625	0,4375	1	1/2	7/16-20	1/4	3/32	3/16
1,125	0,625	0,4375	1	1/2	7/16-20	1/4	3/32	3/16
1,125	0,625	0,4375	1	1/2	7/16-20	1/4	3/32	3/16
1,250	0,750	0,500	1 1/4	5/8	1/2-20	5/16	3/32	3/16
1,250	0,750	0,500	1 1/4	5/8	1/2-20	5/16	3/32	3/16
1,375	0,750	0,500	1 1/4	5/8	1/2-20	5/16	3/32	3/16
1,375	0,750	0,500	1 1/4	5/8	1/2-20	5/16	3/32	3/16
1,500	0,875	0,625	1 1/2	3/4	5/8-18	3/8	3/32	3/16
1,500	0,875	0,625	1 1/2	3/4	5/8-18	3/8	3/32	3/16
1,625	0,875	0,625	1 1/2	3/4	5/8-18	3/8	3/32	3/16
1,625	0,875	0,625	1 1/2	3/4	5/8-18	3/8	3/32	3/16
1,750	1,000	0,750	1 3/4	7/8	3/4-16	7/16	3/32	3/16
1,750	1,000	0,750	1 3/4	7/8	3/4-16	7/16	3/32	3/16



Designation/Type				Recom. clamping torque (lbs-inch)	Load Rating Static (lbs)	Load Rating Dynamic (lbs)	Weight (kg) approx.
TORRINGTON	RBC	ZEN	SMITH				
CRB-8	-	CF-1/2-N-B	CR-1/2-A-B	15	720	620	0.02 kg
CRB-8-1	-	CF-1/2-B	CR-1/2-B	15	790	680	0.02 kg
CRSB-8	-	CF-1/2-N-SB	CR-1/2-A-XB	15	720	620	0.02 kg
CRSB-8-1	S-16-LW	CF-1/2-SB	CR-1/2-XB	15	790	680	0.02 kg
-	-	CF-9/16-B	CR-9/16-B	15	790	680	0.02 kg
-	S-18-LW	CF-9/16-SB	CR-9/16-XB	15	790	680	0.02 kg
CRB-10	-	CF-5/8-N-B	CR-5/8-A-B	35	1085	930	0.02 kg
CRB-10-1	-	CF-5/8-B	CR-5/8-B	35	1215	955	0.02 kg
CRSB-10	-	CF-5/8-N-SB	CR-5/8-A-XB	35	1085	930	0.02 kg
CRSB-10-1	S-20-LW	CF-5/8-SB	CR-5/8-XB	35	1215	955	0.02 kg
-	-	CF-11/16-B	CR-11/16-B	35	1215	955	0.03 kg
-	S-22-LW	CF-11/16-SB	CR-11/16-XB	35	1215	955	0.03 kg
CRB-12	-	CF-3/4-B	CR-3/4-B	95	2065	1660	0.03 kg
CRSB-12	S-24-LW	CF-3/4-SB	CR-3/4-XB	95	2065	1660	0.03 kg
CRB-14	-	CF-7/8-B	CR-7/8-B	95	2065	1660	0.04 kg
CRSB-14	S-28-LW	CF-7/8-SB	CR-7/8-XB	95	2065	1660	0.04 kg
CRB-16	-	CF-1-B	CR-1-B	250	3060	2225	0.08 kg
CRSB-16	S-32-LW	CF-1-SB	CR-1-XB	250	3060	2225	0.08 kg
CRB-18	-	CF-1 1/8-B	CR-1 1/8-B	250	3060	2225	0.09 kg
CRSB-18	S-36-LW	CF-1 1/8-SB	CR-1 1/8-XB	250	3060	2225	0.09 kg
CRB-20	-	CF-1 1/4-B	CR-1 1/4-B	350	4250	3930	0.14 kg
CRSB-20	S-40-LW	CF-1 1/4-SB	CR-1 1/4-XB	350	4250	3930	0.14 kg
CRB-22	-	CF-1 3/8-B	CR-1 3/8-B	350	4250	3930	0.16 kg
CRSB-22	S-44-LW	CF-1 3/8-SB	CR-1 3/8-XB	350	4250	3930	0.16 kg
CRB-24	-	CF-1 1/2-B	CR-1 1/2-B	650	5640	4840	0.24 kg
CRSB-24	S-48-LW	CF-1 1/2-SB	CR-1 1/2-XB	650	5640	4840	0.24 kg
CRB-26	-	CF-1 5/8-B	CR-1 5/8-B	650	5640	4840	0.27 kg
CRSB-26	S-52-LW	CF-1 5/8-SB	CR-1 5/8-XB	650	5640	4840	0.27 kg
CRB-28	-	CF-1 3/4-B	CR-1 3/4-B	1250	7920	6385	0.38 kg
CRSB-28	S-56-LW	CF-1 3/4-SB	CR-1 3/4-XB	1250	7920	6385	0.38 kg

Galets de came avec axe CF...B & CF...SB

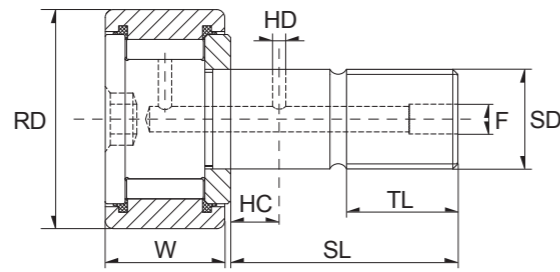
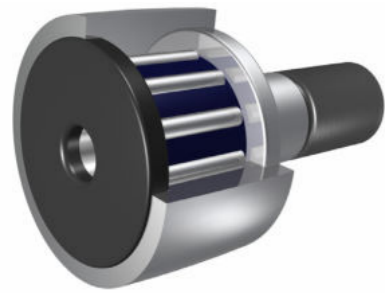

Dimension (inch)								
RD	W	SD	SL	TL	FINE THR'DS	HC	HD	F
1,875	1,000	0,750	1 3/4	7/8	3/4-16	7/16	3/32	3/16
1,875	1,000	0,750	1 3/4	7/8	3/4-16	7/16	3/32	3/16
2,000	1,250	0,875	2	1	7/8-14	1/2	1/8	3/16
2,000	1,250	0,875	2	1	7/8-14	1/2	1/8	3/16
2,500	1,500	1,000	2 1/4	1 1/8	1-14	9/16	1/8	3/16
2,500	1,500	1,000	2 1/4	1 1/8	1-14	9/16	1/8	3/16
2,750	1,500	1,000	2 1/4	1 1/8	1-14	9/16	1/8	3/16
2,750	1,500	1,000	2 1/4	1 1/8	1-14	9/16	1/8	3/16
3,000	1,750	1,250	2 1/2	1 1/4	1 1/4-12	5/8	1/8	1/4
3,000	1,750	1,250	2 1/2	1 1/4	1 1/4-12	5/8	1/8	1/4
3,250	1,250	0,875	2	1	7/8-14	1/2	1/8	3/16
3,250	1,750	1,250	2 1/2	1 1/4	1 1/4-12	5/8	1/8	1/4
3,250	1,250	0,875	2	1	7/8-14	1/2	1/8	3/16
3,250	1,750	1,250	2 1/2	1 1/4	1 1/4-12	5/8	1/8	1/4
3,500	2,000	1,375	2 3/4	1 3/8	1 3/8-12	11/16	1/8	1/4
3,500	2,000	1,375	2 3/4	1 3/8	1 3/8-12	11/16	1/8	1/4
4,000	2,250	1,500	3 1/2	1 1/2	1 1/2-12	3/4	1/8	1/4
4,000	2,250	1,500	3 1/2	1 1/2	1 1/2-12	3/4	1/8	1/4



TORRINGTON	Designation/Type			Recom. clamping torque (lbs-inch)	Load Rating Static (lbs)	Load Rating Dynamic (lbs)	Weight (kg) approx.
	RBC	ZEN	SMITH				
CRB-30	-	CF-1 7/8-B	CR-1 7/8-B	1250	7920	6385	0.43 kg
CRSB-30	S-60-LW	CF-1 7/8-SB	CR-1 7/8-XB	1250	7920	6385	0.43 kg
CRB-32	-	CF-2-B	CR-2-B	1500	10570	8090	0.62 kg
CRSB-32	S-64-LW	CF-2-SB	CR-2-XB	1500	10570	8090	0.62 kg
CRB-40	-	CF-2 1/2-B	CR-2 1/2-B	2250	16450	11720	1.13 kg
CRSB-40	S-80-LW	CF-2 1/2-SB	CR-2 1/2-XB	2250	16450	11720	1.13 kg
CRB-44	-	CF-2 3/4-B	CR-2 3/4-B	2250	16450	11720	1.33 kg
CRSB-44	S-88-LW	CF-2 3/4-SB	CR-2 3/4-XB	2250	16450	11720	1.33 kg
CRB-48	-	CF-3-B	CR-3-B	3450	24910	15720	1.91 kg
CRSB-48	S-96-LW	CF-3-SB	CR-3-XB	3450	24910	15720	1.91 kg
CRB-36	-	CF-2 1/4-B	CR-2 1/4-B	1500	10570	8090	0.75 kg
CRB-52	-	CF-3 1/4-B	CR-3 1/4-B	3450	24910	15720	2.18 kg
CRSB-36	S-72-LW	CF-2 1/4-SB	CR-2 1/4-XB	1500	10570	8090	0.75 kg
CRSB-52	S-104-LW	CF-3 1/4-SB	CR-3 1/4-XB	3450	24910	15720	2.18 kg
CRB-56	-	CF-3 1/2-B	CR-3 1/2-B	4200	31625	22800	2.91 kg
CRSB-56	S-112-LW	CF-3 1/2-SB	CR-3 1/2-XB	4200	31625	22800	2.91 kg
CRB-64	-	CF-4-B	CR-4-B	5000	44770	29985	4.29 kg
CRSB-64	S-128-LW	CF-4-SB	CR-4-XB	5000	44770	29985	4.29 kg

Galets de came avec axe CFE & CFE...S

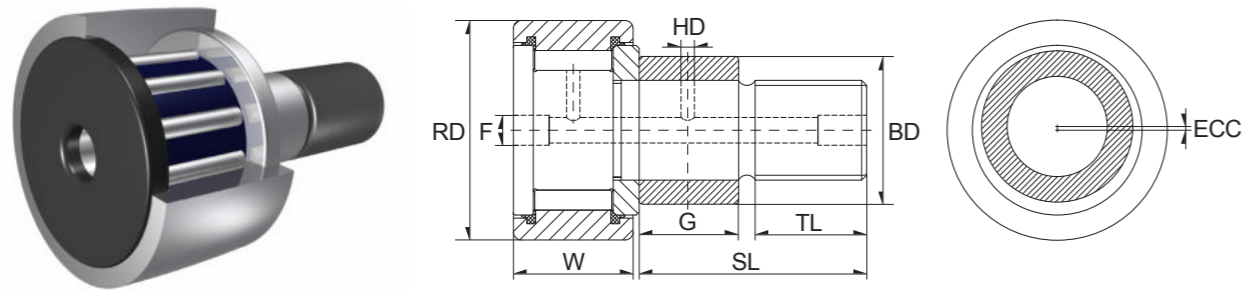

Dimension (inch)								
RD	W	G	BD	SL	TL	FINE THR'DS	ECC	F
0,500	0,375	0,375	0,250	5/8	1/4	10-32	0,010	1/8
0,500	0,375	0,375	0,250	5/8	1/4	10-32	0,010	1/8
0,5625	0,375	0,375	0,250	5/8	1/4	10-32	0,010	1/8
0,5625	0,375	0,375	0,250	5/8	1/4	10-32	0,010	1/8
0,625	0,4375	0,437	0,375	3/4	5/16	1/4-28	0,015	1/8
0,625	0,4375	0,437	0,375	3/4	5/16	1/4-28	0,015	1/8
0,6875	0,4375	0,437	0,375	3/4	5/16	1/4-28	0,015	1/8
0,6875	0,4375	0,437	0,375	3/4	5/16	1/4-28	0,015	1/8
0,750	0,500	0,500	0,500	7/8	3/8	3/8-24	0,015	3/16
0,750	0,500	0,500	0,500	7/8	3/8	3/8-24	0,015	3/16
0,875	0,500	0,500	0,500	7/8	3/8	3/8-24	0,015	3/16
0,875	0,500	0,500	0,500	7/8	3/8	3/8-24	0,015	3/16
1,000	0,625	0,500	0,625	1	1/2	7/16-20	0,030	3/16
1,000	0,625	0,500	0,625	1	1/2	7/16-20	0,030	3/16
1,125	0,625	0,500	0,625	1	1/2	7/16-20	0,030	3/16
1,125	0,625	0,500	0,625	1	1/2	7/16-20	0,030	3/16
1,250	0,750	0,625	0,687	1 1/4	5/8	1/2-20	0,030	3/16
1,250	0,750	0,625	0,687	1 1/4	5/8	1/2-20	0,030	3/16
1,375	0,750	0,625	0,687	1 1/4	5/8	1/2-20	0,030	3/16
1,375	0,750	0,625	0,687	1 1/4	5/8	1/2-20	0,030	3/16
1,500	0,875	0,750	0,875	1 1/2	3/4	5/8-18	0,030	3/16
1,500	0,875	0,750	0,875	1 1/2	3/4	5/8-18	0,030	3/16
1,625	0,875	0,750	0,875	1 1/2	3/4	5/8-18	0,030	3/16
1,625	0,875	0,750	0,875	1 1/2	3/4	5/8-18	0,030	3/16
1,750	1,000	0,875	1,000	1 3/4	7/8	3/4-16	0,030	3/16
1,750	1,000	0,875	1,000	1 3/4	7/8	3/4-16	0,030	3/16
1,875	1,000	0,875	1,000	1 3/4	7/8	3/4-16	0,030	3/16
1,875	1,000	0,875	1,000	1 3/4	7/8	3/4-16	0,030	3/16
2,000	1,250	1,000	1,187	2	1	7/8-14	0,030	3/16
2,000	1,250	1,000	1,187	2	1	7/8-14	0,030	3/16



TORRINGTON	Designation/Type			Recom. clamping torque (lbs-inch)	Load Rating Static (lbs)	Load Rating Dynamic (lbs)	Weight (kg) approx.
	RBC	ZEN	SMITH				
CRE-8-1	-	CFE-1/2	CR-1/2-E	15	790	680	0.02 kg
CRSE-8-1	-	CFE-1/2-S	CR-1/2-XE	15	790	680	0.02 kg
-	-	CFE-9/16	CR-9/16-E	15	790	680	0.02 kg
-	-	CFE-9/16-S	CR-9/16-XE	15	790	680	0.02 kg
CRE-10-1	-	CFE-5/8	CR-5/8-E	35	1215	955	0.02 kg
CRSE-10-1	-	CFE-5/8-S	CR-5/8-XE	35	1215	955	0.02 kg
-	-	CFE-11/16	CR-11/16-E	35	1215	955	0.03 kg
-	-	CFE-11/16-S	CR-11/16-XE	35	1215	955	0.03 kg
CRE-12	-	CFE-3/4	CR-3/4-E	95	2065	1660	0.03 kg
CRSE-12	-	CFE-3/4-S	CR-3/4-XE	95	2065	1660	0.03 kg
CRE-14	-	CFE-7/8	CR-7/8-E	95	2065	1660	0.04 kg
CRSE-14	-	CFE-7/8-S	CR-7/8-XE	95	2065	1660	0.04 kg
CRE-16	-	CFE-1	CR-1-E	250	3060	2225	0.08 kg
CRSE-16	-	CFE-1-S	CR-1-XE	250	3060	2225	0.08 kg
CRE-18	-	CFE-1 1/8	CR-1 1/8-E	250	3060	2225	0.09 kg
CRSE-18	-	CFE-1 1/8-S	CR-1 1/8-XE	250	3060	2225	0.09 kg
CRE-20	-	CFE-1 1/4	CR-1 1/4-E	350	4250	3930	0.14 kg
CRSE-20	-	CFE-1 1/4-S	CR-1 1/4-XE	350	4250	3930	0.14 kg
CRE-22	-	CFE-1 3/8	CR-1 3/8-E	350	4250	3930	0.16 kg
CRSE-22	-	CFE-1 3/8-S	CR-1 3/8-XE	350	4250	3930	0.16 kg
CRE-24	-	CFE-1 1/2	CR-1 1/2-E	650	5640	4840	0.24 kg
CRSE-24	-	CFE-1 1/2-S	CR-1 1/2-XE	650	5640	4840	0.24 kg
CRE-26	-	CFE-1 5/8	CR-1 5/8-E	650	5640	4840	0.27 kg
CRSE-26	-	CFE-1 5/8-S	CR-1 5/8-XE	650	5640	4840	0.27 kg
CRE-28	-	CFE-1 3/4	CR-1 3/4-E	1250	7920	6385	0.38 kg
CRSE-28	-	CFE-1 3/4-S	CR-1 3/4-XE	1250	7920	6385	0.38 kg
CRE-30	-	CFE-1 7/8	CR-1 7/8-E	1250	7920	6385	0.43 kg
CRSE-30	-	CFE-1 7/8-S	CR-1 7/8-XE	1250	7920	6385	0.43 kg
CRE-32	-	CFE-2	CR-2-E	1500	10570	8090	0.62 kg
CRSE-32	-	CFE-2-S	CR-2-XE	1500	10570	8090	0.62 kg

Galets de came avec axe CFE & CFE...S

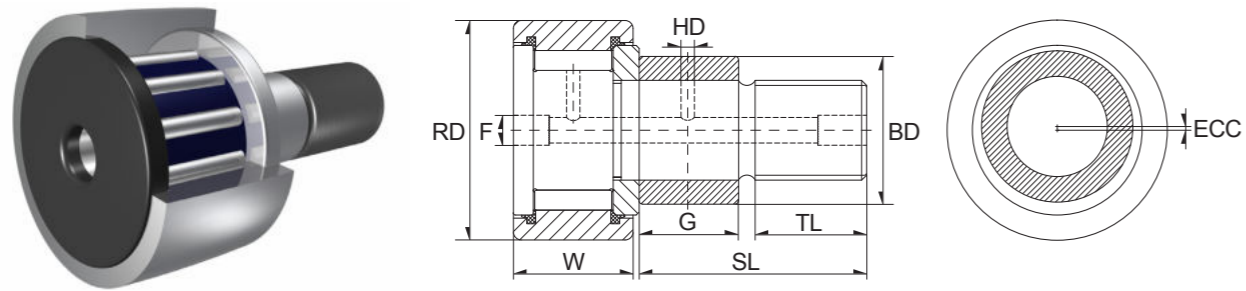

Dimension (inch)								
RD	W	G	BD	SL	TL	FINE THR'DS	ECC	F
2,250	1,250	1,000	1,187	2	1	7/8-14	0,030	3/16
2,250	1,250	1,000	1,187	2	1	7/8-14	0,030	3/16
2,500	1,500	1,125	1,375	2 1/4	1 1/8	1-14	0,030	3/16
2,500	1,500	1,125	1,375	2 1/4	1 1/8	1-14	0,030	3/16
2,750	1,500	1,125	1,375	2 1/4	1 1/8	1-14	0,030	3/16
2,750	1,500	1,125	1,375	2 1/4	1 1/8	1-14	0,030	3/16
3,000	1,750	1,250	1,750	2 1/2	1 1/4	1 1/4-12	0,060	1/4
3,000	1,750	1,250	1,750	2 1/2	1 1/4	1 1/4-12	0,060	1/4
3,250	1,750	1,250	1,750	2 1/2	1 1/4	1 1/4-12	0,060	1/4
3,250	1,750	1,250	1,750	2 1/2	1 1/4	1 1/4-12	0,060	1/4
3,500	2,000	1,375	1,812	2 3/4	1 3/8	1 3/8-12	0,060	1/4
3,500	2,000	1,375	1,812	2 3/4	1 3/8	1 3/8-12	0,060	1/4
4,000	2,250	2,000	2,000	3 1/2	1 1/2	1 1/2-12	0,060	1/4
4,000	2,250	2,000	2,000	3 1/2	1 1/2	1 1/2-12	0,060	1/4



TORRINGTON	Designation/Type			Recom. clamping torque (lbs-inch)	Load Rating Static (lbs)	Load Rating Dynamic (lbs)	Weight (kg) approx.
	RBC	ZEN	SMITH				
CRE-36	-	CFE-2 1/4	CR-2 1/4-E	1500	10570	8090	0.75 kg
CRSE-36	-	CFE-2 1/4-S	CR-2 1/4-XE	1500	10570	8090	0.75 kg
CRE-40	-	CFE-2 1/2	CR-2 1/2-E	2250	16450	117200	1.13 kg
CRSE-40	-	CFE-2 1/2-S	CR-2 1/2-XE	2250	16450	117200	1.13 kg
CRE-44	-	CFE-2 3/4	CR-2 3/4-E	2250	16450	117200	1.33 kg
CRSE-44	-	CFE-2 3/4-S	CR-2 3/4-XE	2250	16450	117200	1.33 kg
CRE-48	-	CFE-3	CR-3-E	3450	24910	15720	1.91 kg
CRSE-48	-	CFE-3-S	CR-3-XE	3450	24910	15720	1.91 kg
CRE-52	-	CFE-3 1/4	CR-3 1/4-E	3450	14910	15720	2.18 kg
CRSE-52	-	CFE-3 1/4-S	CR-3 1/4-XE	3450	14910	15720	2.18 kg
CRE-56	-	CFE-3 1/2	CR-3 1/2-E	4200	31625	22800	2.91 kg
CRSE-56	-	CFE-3 1/2-S	CR-3 1/2-XE	4200	31625	22800	2.91 kg
CRE-64	-	CFE-4	CR-4-E	5000	44770	29985	4.29 kg
CRSE-64	-	CFE-4-S	CR-4-XE	5000	44770	29985	4.29 kg

Galets de came avec axe CFE...B & CFE...SB

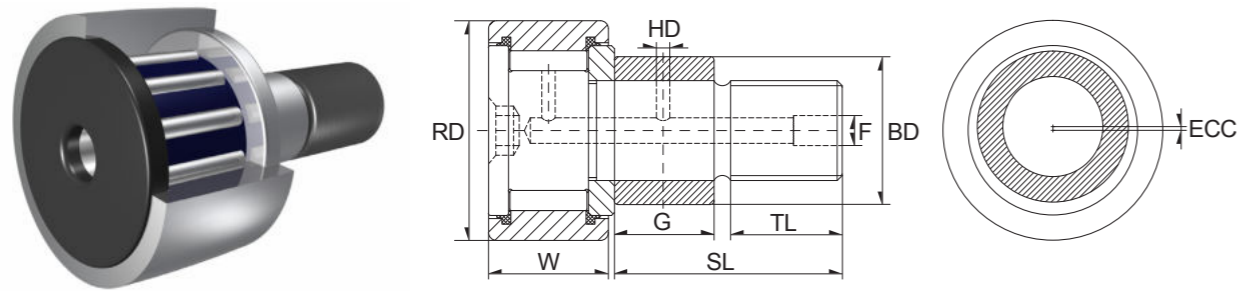

Dimension (inch)								
RD	W	G	BD	SL	TL	FINE THR'DS	ECC	F
0,500	0,344	0,250	0,250	1/2	1/4	10-32	0,010	-
0,500	0,375	0,375	0,250	5/8	1/4	10-32	0,010	-
0,500	0,344	0,250	0,250	1/2	1/4	10-32	0,010	-
0,500	0,375	0,375	0,250	5/8	1/4	10-32	0,010	-
0,5625	0,375	0,375	0,250	5/8	1/4	10-32	0,010	-
0,5625	0,375	0,375	0,250	5/8	1/4	10-32	0,010	-
0,625	0,4375	0,437	0,375	3/4	5/16	1/4-28	0,015	-
0,625	0,4375	0,437	0,375	3/4	5/16	1/4-28	0,015	-
0,6875	0,4375	0,437	0,375	3/4	5/16	1/4-28	0,015	-
0,6875	0,4375	0,437	0,375	3/4	5/16	1/4-28	0,015	-
0,750	0,500	0,500	0,500	7/8	3/8	3/8-24	0,015	3/16
0,750	0,500	0,500	0,500	7/8	3/8	3/8-24	0,015	3/16
0,875	0,500	0,500	0,500	7/8	3/8	3/8-24	0,015	3/16
0,875	0,500	0,500	0,500	7/8	3/8	3/8-24	0,015	3/16
1,000	0,625	0,500	0,625	1	1/2	7/16-20	0,030	3/16
1,000	0,625	0,500	0,625	1	1/2	7/16-20	0,030	3/16
1,125	0,625	0,500	0,625	1	1/2	7/16-20	0,030	3/16
1,125	0,625	0,500	0,625	1	1/2	7/16-20	0,030	3/16
1,250	0,750	0,625	0,687	1 1/4	5/8	1/2-20	0,030	3/16
1,250	0,750	0,625	0,687	1 1/4	5/8	1/2-20	0,030	3/16
1,375	0,750	0,625	0,687	1 1/4	5/8	1/2-20	0,030	3/16
1,375	0,750	0,625	0,687	1 1/4	5/8	1/2-20	0,030	3/16
1,500	0,875	0,750	0,875	1 1/2	3/4	5/8-18	0,030	3/16
1,500	0,875	0,750	0,875	1 1/2	3/4	5/8-18	0,030	3/16
1,625	0,875	0,750	0,875	1 1/2	3/4	5/8-18	0,030	3/16
1,625	0,875	0,750	0,875	1 1/2	3/4	5/8-18	0,030	3/16
1,750	1,000	0,875	1,000	1 3/4	7/8	3/4-16	0,030	3/16
1,750	1,000	0,875	1,000	1 3/4	7/8	3/4-16	0,030	3/16
1,875	1,000	0,875	1,000	1 3/4	7/8	3/4-16	0,030	3/16
1,875	1,000	0,875	1,000	1 3/4	7/8	3/4-16	0,030	3/16



Designation/Type				Recom. clamping torque (lbs-inch)	Load Rating Static (lbs)	Load Rating Dynamic (lbs)	Weight (kg) approx.
TORRINGTON	RBC	ZEN	SMITH				
-	-	CFE-1/2-N-B	CR-1/2-N-BE	15	720	620	0.02 kg
CRBE-8-1	-	CFE-1/2-B	CR-1/2-BE	15	790	680	0.02 kg
-	-	CFE-1/2-N-SB	CR-1/2-A-XBE	15	720	620	0.02 kg
CRSBE-8-1	S-16-LWX	CFE-1/2-SB	CR-1/2-XBE	15	790	680	0.02 kg
-	-	CFE-9/16-B	CR-9/16-BE	15	790	680	0.02 kg
-	S-18-LWX	CFE-9/16-SB	CR-9/16-XBE	15	790	680	0.02 kg
CRBE-10-1	-	CFE-5/8-B	CR-5/8-BE	35	1215	955	0.02 kg
CRSBE-10-1	S-20-LWX	CFE-5/8-SB	CR-5/8-XBE	35	1215	955	0.02 kg
-	-	CFE-11/16-B	CR-11/16-BE	35	1215	955	0.03 kg
-	S-22-LWX	CFE-11/16-SB	CR-11/16-XBE	35	1215	955	0.03 kg
CRBE-12	-	CFE-3/4-B	CR-3/4-BE	95	2065	1660	0.03 kg
CRSBE-12	S-24-LWX	CFE-3/4-SB	CR-3/4-XBE	95	2065	1660	0.03 kg
CRBE-14	-	CFE-7/8-B	CR-7/8-BE	95	2065	1660	0.04 kg
CRSBE-14	S-28-LWX	CFE-7/8-SB	CR-7/8-XBE	95	2065	1660	0.04 kg
CRBE-16	-	CFE-1-B	CR-1-BE	250	3060	2225	0.08 kg
CRSBE-16	S-32-LWX	CFE-1-SB	CR-1-XBE	250	3060	2225	0.08 kg
CRBE-18	-	CFE-1 1/8-B	CR-1 1/8-BE	250	3060	2225	0.09 kg
CRSBE-18	S-36-LWX	CFE-1 1/8-SB	CR-1 1/8-XBE	250	3060	2225	0.09 kg
CRBE-20	-	CFE-1 1/4-B	CR-1 1/4-BE	350	4250	3930	0.14 kg
CRSBE-20	S-40-LWX	CFE-1 1/4-SB	CR-1 1/4-XBE	350	4250	3930	0.14 kg
CRBE-22	-	CFE-1 3/8-B	CR-1 3/8-BE	350	4250	3930	0.16 kg
CRSBE-22	S-44-LWX	CFE-1 3/8-SB	CR-1 3/8-XBE	350	4250	3930	0.16 kg
CRBE-24	-	CFE-1 1/2-B	CR-1 1/2-BE	650	5640	4840	0.24 kg
CRSBE-24	S-48-LWX	CFE-1 1/2-SB	CR-1 1/2-XBE	650	5640	4840	0.24 kg
CRBE-26	-	CFE-1 5/8-B	CR-1 5/8-BE	650	5640	4840	0.27 kg
CRSBE-26	S-52-LWX	CFE-1 5/8-SB	CR-1 5/8-XBE	650	5640	4840	0.27 kg
CRBE-28	-	CFE-1 3/4-B	CR-1 3/4-BE	1250	7920	6385	0.38 kg
CRSBE-28	S-56-LWX	CFE-1 3/4-SB	CR-1 3/4-XBE	1250	7920	6385	0.38 kg
CRBE-30	-	CFE-1 7/8-B	CR-1 7/8-BE	1250	7920	6385	0.43 kg
CRSBE-30	S-60-LWX	CFE-1 7/8-SB	CR-1 7/8-XBE	1250	7920	6385	0.43 kg

Galets de came avec axe CFE...B & CFE...SB

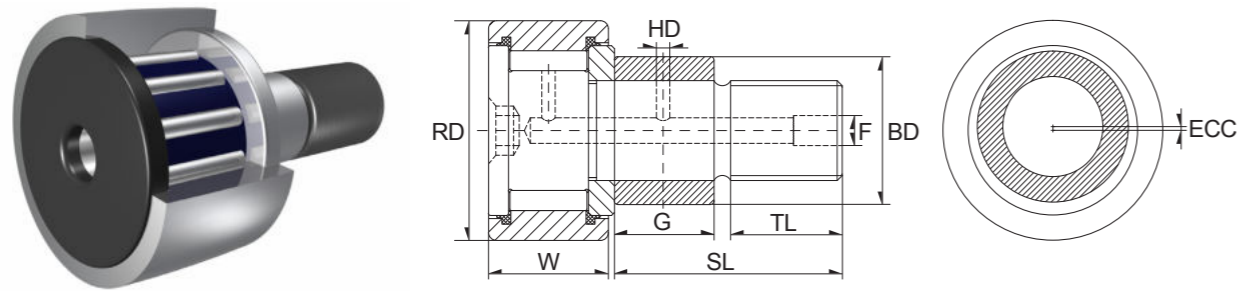

Dimension (inch)								
RD	W	G	BD	SL	TL	FINE THR'DS	ECC	F
2,000	1,250	1,000	1,187	2	1	7/8-14	0,030	3/16
2,000	1,250	1,000	1,187	2	1	7/8-14	0,030	3/16
2,250	1,250	1,000	1,187	2	1	7/8-14	0,030	3/16
2,250	1,250	1,000	1,187	2	1	7/8-14	0,030	3/16
2,500	1,500	1,125	1,375	2 1/4	1 1/8	1-14	0,030	3/16
2,500	1,500	1,125	1,375	2 1/4	1 1/8	1-14	0,030	3/16
2,750	1,500	1,125	1,375	2 1/4	1 1/8	1-14	0,030	3/16
2,750	1,500	1,125	1,375	2 1/4	1 1/8	1-14	0,030	3/16
3,000	1,750	1,250	1,750	2 1/2	1 1/4	1 1/4-12	0,060	1/4
3,000	1,750	1,250	1,750	2 1/2	1 1/4	1 1/4-12	0,060	1/4
3,250	1,750	1,250	1,750	2 1/2	1 1/4	1 1/4-12	0,060	1/4
3,250	1,750	1,250	1,750	2 1/2	1 1/4	1 1/4-12	0,060	1/4
3,500	2,000	1,375	1,812	2 3/4	1 3/8	1 3/8-12	0,060	1/4
3,500	2,000	1,375	1,812	2 3/4	1 3/8	1 3/8-12	0,060	1/4
4,000	2,250	2,000	2,000	3 1/2	1 1/2	1 1/2-12	0,060	1/4
4,000	2,250	2,000	2,000	3 1/2	1 1/2	1 1/2-12	0,060	1/4



TORRINGTON	Designation/Type			Recom. clamping torque (lbs-inch)	Load Rating Static (lbs)	Load Rating Dynamic (lbs)	Weight (kg) approx.
	RBC	ZEN	SMITH				
CRBE-32	-	CFE-2-B	CR-2-BE	1500	10570	8090	0.62 kg
CRSBE-32	S-64-LWX	CFE-2-SB	CR-2-XBE	1500	10570	8090	0.62 kg
CRBE-36	-	CFE-2 1/4-B	CR-2 1/4-BE	1500	10570	8090	0.75 kg
CRSBE-36	S-72-LWX	CFE-2 1/4-SB	CR-2 1/4-XBE	1500	10570	8090	0.75 kg
CRBE-40	-	CFE-2 1/2-B	CR-2 1/2-BE	2250	16450	11720	1.13 kg
CRSBE-40	S-80-LWX	CFE-2 1/2-SB	CR-2 1/2-XBE	2250	16450	11720	1.13 kg
CRBE-44	-	CFE-2 3/4-B	CR-2 3/4-BE	2250	16450	11720	1.33 kg
CRSBE-44	S-88-LWX	CFE-2 3/4-SB	CR-2 3/4-XBE	2250	16450	11720	1.33 kg
CRBE-48	-	CFE-3-B	CR-3-BE	3450	24910	15720	1.91 kg
CRSBE-48	S-96-LWX	CFE-3-SB	CR-3-XBE	3450	24910	15720	1.91 kg
CRBE-52	-	CFE-3 1/4-B	CR-3 1/4-BE	3450	24910	15720	2.18 kg
CRSBE-52	S-104-LWX	CFE-3 1/4-SB	CR-3 1/4-XBE	3450	24910	15720	2.18 kg
CRBE-56	-	CFE-3 1/2-B	CR-3 1/2-BE	4200	31625	22800	2.91 kg
CRSBE-56	S-112-LWX	CFE-3 1/2-SB	CR-3 1/2-XBE	4200	31625	22800	2.91 kg
CRBE-64	-	CFE-4-B	CR-4-BE	5000	44770	29985	4.29 kg
CRSBE-64	S-128-LWX	CFE-4-SB	CR-4-XBE	5000	44770	29985	4.29 kg

Galets de came avec axe CCF...S

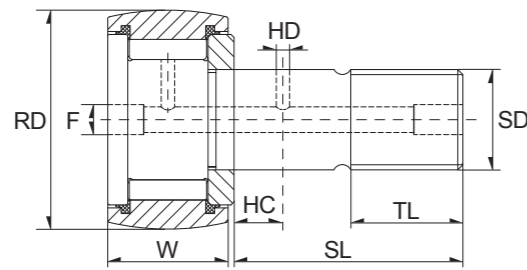
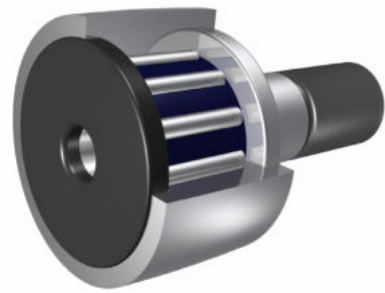

Dimension (inch)								
RD	W	SD	SL	TL	FINE THR'DS	HC	HD	F
0,500	0,344	0,190	1/2	1/4	10-32	-	-	1/8
0,500	0,375	0,190	5/8	1/4	10-32	-	-	1/8
0,5625	0,375	0,190	5/8	1/4	10-32	-	-	1/8
0,625	0,406	0,250	5/8	5/16	1/4-28	-	-	1/8
0,625	0,4375	0,250	3/4	5/16	1/4-28	-	-	1/8
0,6875	0,4375	0,250	3/4	5/16	1/4-28	-	-	1/8
0,750	0,500	0,375	7/8	3/8	3/8-24	1/4	3/32	3/16
0,875	0,500	0,375	7/8	3/8	3/8-24	1/4	3/32	3/16
1,000	0,625	0,4375	1	1/2	7/16-20	1/4	3/32	3/16
1,125	0,625	0,4375	1	1/2	7/16-20	1/4	3/32	3/16
1,250	0,750	0,500	1 1/4	5/8	1/2-20	5/16	3/32	3/16
1,375	0,750	0,500	1 1/4	5/8	1/2-20	5/16	3/32	3/16
1,500	0,875	0,625	1 1/2	3/4	5/8-18	3/8	3/32	3/16
1,625	0,875	0,625	1 1/2	3/4	5/8-18	3/8	3/32	3/16
1,750	1,000	0,750	1 3/4	7/8	3/4-16	7/16	3/32	3/16
1,875	1,000	0,750	1 3/4	7/8	3/4-16	7/16	3/32	3/16
2,000	1,250	0,875	2	1	7/8-14	1/2	1/8	3/16
2,250	1,250	0,875	2	1	7/8-14	1/2	1/8	3/16
2,500	1,500	1,000	2 1/4	1 1/8	1-14	9/16	1/8	3/16
2,750	1,500	1,000	2 1/4	1 1/8	1-14	9/16	1/8	3/16
3,000	1,750	1,250	2 1/2	1 1/4	1 1/4-12	5/8	1/8	1/4
3,250	1,750	1,250	2 1/2	1 1/4	1 1/4-12	5/8	1/8	1/4
3,500	2,000	1,375	2 3/4	1 3/8	1 3/8-12	11/16	1/8	1/4
4,000	2,250	1,500	3 1/2	1 1/2	1 1/2-12	3/4	1/8	1/4
5,000	2,750	2,000	5 1/16	2 9/16	2-12	7/8	3/16	1/4
6,000	3,250	2,500	6	3	2 1/2-12	1	3/16	1/4
7,000	3,750	3,000	7 11/16	4 1/8	3-12	1 1/4	3/16	1/4
8,000	4,250	3,250	8 1/2	4 1/4	3 1/4-4	-	-	1/4
9,000	4,750	3,750	9 1/2	4 3/4	3 1/2-4	-	-	1/4
10,000	2,250	4,250	10	4 3/4	3 1/2-4	-	-	1/4



Designation/Type				Recom. clamping torque (lbs-inch)	Load Rating Static (lbs)	Load Rating Dynamic (lbs)	Weight (kg) approx.
TORRINGTON	RBC	ZEN	SMITH				
-	-	CCF-1/2-N-S	CR-1/2-A-XC	15	720	620	0.02 kg
CRSC-8-1	-	CCF-1/2-S	CR-1/2-XC	15	790	680	0.02 kg
-	-	CCF-9/16-S	CR-9/16-XC	15	790	680	0.02 kg
-	-	CCF-5/8-N-S	CR-5/8-A-XC	35	1085	930	0.02 kg
CRSC-10-1	-	CCF-5/8-S	CR-5/8-XC	35	1215	955	0.02 kg
-	-	CCF-11/16-S	CR-11/16-XC	35	1215	955	0.03 kg
CRSC-12	CS-24-L	CCF-3/4-S	CR-3/4-XC	95	2065	1660	0.03 kg
CRSC-14	CS-28-L	CCF-7/8-S	CR-7/8-XC	95	2065	1660	0.04 kg
CRSC-16	CS-32-L	CCF-1-S	CR-1-XC	250	3060	2225	0.08 kg
CRSC-18	CS-36-L	CCF-1 1/8-S	CR-1 1/8-XC	250	3060	2225	0.09 kg
CRSC-20	CS-40-L	CCF-1 1/4-S	CR-1 1/4-XC	350	4250	3930	0.14 kg
CRSC-22	CS-44-L	CCF-1 3/8-S	CR-1 3/8-XC	350	4250	3930	0.16 kg
CRSC-24	CS-48-L	CCF-1 1/2-S	CR-1 1/2-XC	650	5640	4840	0.24 kg
CRSC-26	CS-52-L	CCF-1 5/8-S	CR-1 5/8-XC	650	5640	4840	0.27 kg
CRSC-28	CS-56-L	CCF-1 3/4-S	CR-1 3/4-XC	1250	7920	6385	0.38 kg
CRSC-30	CS-60-L	CCF-1 7/8-S	CR-1 7/8-XC	1250	7920	6385	0.43 kg
CRSC-32	CS-64-L	CCF-2-S	CR-2-XC	1500	10570	8090	0.62 kg
CRSC-36	CS-72-L	CCF-2 1/4-S	CR-2 1/4-XC	1500	10570	8090	0.75 kg
CRSC-40	CS-80-L	CCF-2 1/2-S	CR-2 1/2-XC	2250	16450	11720	1.13 kg
CRSC-44	CS-88-L	CCF-2 3/4-S	CR-2 3/4-XC	2250	16450	11720	1.33 kg
CRSC-48	CS-96-L	CCF-3-S	CR-3-XC	3450	24910	15720	1.91 kg
CRSC-52	CS-104-L	CCF-3 1/4-S	CR-3 1/4-XC	3450	24910	15720	2.18 kg
CRSC-56	CS-112-L	CCF-3 1/2-S	CR-3 1/2-XC	4200	31625	22800	2.91 kg
CRSC-64	CS-128-L	CCF-4-S	CR-4-XC	5000	44770	29985	4.29 kg
-	-	CCF-5-S	CR-5-XC	5000	67950	46575	8.89 kg
-	-	CCF-6-S	CR-6-XC	5000	80450	60000	14.85 kg
-	-	CCF-7-S	CR-7-XC	5000	106930	75380	24.83 kg
-	-	CCF-8-S	CR-8-XC	5000	144100	92200	36.20 kg
-	-	CCF-9-S	CR-9-XC	5000	183430	113260	50.62 kg
-	-	CCF-10-S	CR-10-XC	5000	215565	131545	67.22 kg

Galets de came avec axe CCF...SB

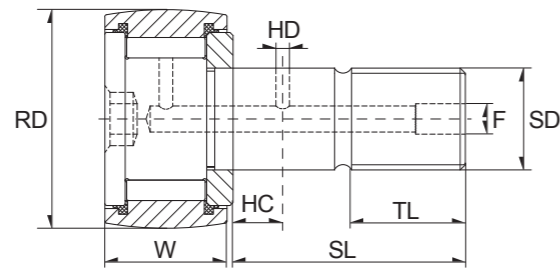
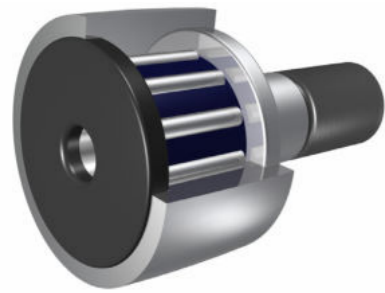

Dimension (inch)								
RD	W	SD	SL	TL	FINE THR'DS	HC	HD	F
0,500	0,344	0,190	1/2	1/4	10-32	-	-	-
0,500	0,375	0,190	5/8	1/4	10-32	-	-	-
0,5625	0,375	0,190	5/8	1/4	10-32	-	-	-
0,625	0,406	0,250	5/8	5/16	1/4-28	-	-	-
0,625	0,4375	0,250	3/4	5/16	1/4-28	-	-	-
0,6875	0,4375	0,250	3/4	5/16	1/4-28	-	-	-
0,750	0,500	0,375	7/8	3/8	3/8-24	1/4	3/32	3/16
0,875	0,500	0,375	7/8	3/8	3/8-24	1/4	3/32	3/16
1,000	0,625	0,4375	1	1/2	7/16-20	1/4	3/32	3/16
1,125	0,625	0,4375	1	1/2	7/16-20	1/4	3/32	3/16
1,250	0,750	0,500	1 1/4	5/8	1/2-20	5/16	3/32	3/16
1,500	0,875	0,625	1 1/2	3/4	5/8-18	3/8	3/32	3/16
1,625	0,875	0,625	1 1/2	3/4	5/8-18	3/8	3/32	3/16
1,750	0,750	0,500	1 1/4	5/8	1/2-20	5/16	3/32	3/16
1,750	1,000	0,750	1 3/4	7/8	3/4-16	7/16	3/32	3/16
1,875	1,000	0,750	1 3/4	7/8	3/4-16	7/16	3/32	3/16
2,000	1,250	0,875	2	1	7/8-14	1/2	1/8	3/16
2,250	1,250	0,875	2	1	7/8-14	1/2	1/8	3/16
2,500	1,500	1,000	2 1/4	1 1/8	1-14	9/16	1/8	3/16
2,750	1,500	1,000	2 1/4	1 1/8	1-14	9/16	1/8	3/16
3,000	1,750	1,250	2 1/2	1 1/4	1 1/4-12	5/8	1/8	1/4
3,250	1,750	1,250	2 1/2	1 1/4	1 1/4-12	5/8	1/8	1/4
3,500	2,000	1,375	2 3/4	1 3/8	1 3/8-12	11/16	1/8	1/4
4,000	2,250	1,500	3 1/2	1 1/2	1 1/2-12	3/4	1/8	1/4



Designation/Type				Recom. clamping torque (lbs-inch)	Load Rating Static (lbs)	Load Rating Dynamic (lbs)	Weight (kg) approx.
TORRINGTON	RBC	ZEN	SMITH				
-	-	CCF-1/2-N-SB	CR-1/2-A-XBC	15	720	620	0.02 kg
CRSBC-8-1	CS-16-LW	CCF-1/2-SB	CR-1/2-XBC	15	790	680	0.02 kg
-	CS-18-LW	CCF-9/16-SB	CR-9/16-XBC	15	790	680	0.02 kg
-	-	CCF-5/8-N-SB	CR-5/8-A-XBC	35	1085	930	0.02 kg
CRSBC-10-1	CS-20-LW	CCF-5/8-SB	CR-5/8-XBC	35	1215	955	0.02 kg
-	CS-22-LW	CCF-11/16-SB	CR-11/16-XBC	35	1215	955	0.03 kg
CRSBC-12	CS-24-LW	CCF-3/4-SB	CR-3/4-XBC	95	2065	1660	0.03 kg
CRSBC-14	CS-28-LW	CCF-7/8-SB	CR-7/8-XBC	95	2065	1660	0.04 kg
CRSBC-16	CS-32-LW	CCF-1-SB	CR-1-XBC	250	3060	2225	0.08 kg
CRSBC-18	CS-36-LW	CCF-1 1/8-SB	CR-1 1/8-XBC	250	3060	2225	0.09 kg
CRSBC-20	CS-40-LW	CCF-1 1/4-SB	CR-1 1/4-XBC	350	4250	3930	0.14 kg
CRSBC-24	CS-48-LW	CCF-1 1/2-SB	CR-1 1/2-XBC	650	5640	4840	0.24 kg
CRSBC-26	CS-52-LW	CCF-1 5/8-SB	CR-1 5/8-XBC	650	5640	4840	0.27 kg
CRSBC-22	CS-44-LW	CCF-1 3/8-SB	CR-1 3/8-XBC	350	4250	3930	0.16 kg
CRSBC-28	CS-56-LW	CCF-1 3/4-SB	CR-1 3/4-XBC	1250	7920	6385	0.38 kg
CRSBC-30	CS-60-LW	CCF-1 7/8-SB	CR-1 7/8-XBC	1250	7920	6385	0.43 kg
CRSBC-32	CS-64-LW	CCF-2-SB	CR-2-XBC	1500	10570	8090	0.62 kg
CRSBC-36	CS-72-LW	CCF-2 1/4-SB	CR-2 1/4-XBC	1500	10570	8090	0.75 kg
CRSBC-40	CS-80-LW	CCF-2 1/2-SB	CR-2 1/2-XBC	2250	16450	11720	1.13 kg
CRSBC-44	CS-88-LW	CCF-2 3/4-SB	CR-2 3/4-XBC	2250	16450	11720	1.33 kg
CRSBC-48	CS-96-LW	CCF-3-SB	CR-3-XBC	3450	24910	15720	1.91 kg
CRSBC-52	CS-104-LW	CCF-3 1/4-SB	CR-3 1/4-XBC	3450	24910	15720	2.18 kg
CRSBC-56	CS-112-LW	CCF-3 1/2-SB	CR-3 1/2-XBC	4200	31625	22800	2.91 kg
CRSBC-64	CS-128-LW	CCF-4-SB	CR-4-XBC	5000	44770	29985	4.29 kg

Galets de came avec axe CCFE...S

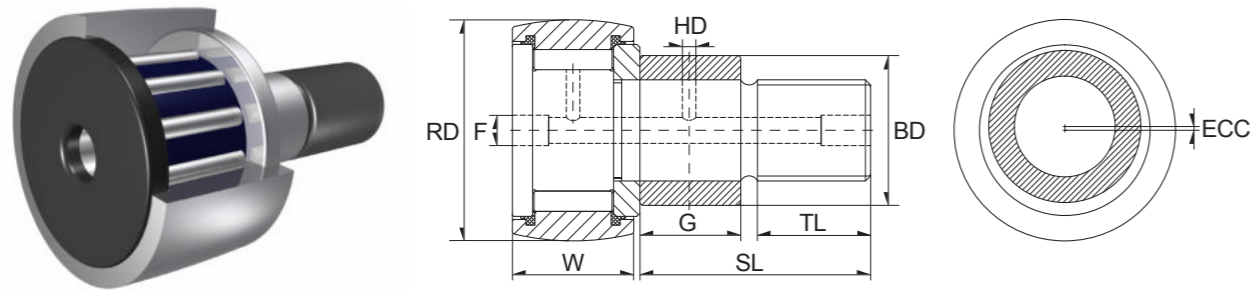

Dimension (inch)								
RD	W	G	BD	SL	TL	FINE THR'DS	EEC	F
0,375	0,750	0,625	0,687	1 1/4	5/8	1/2-20	0,030	3/16
0,500	0,344	0,250	0,250	1/2	1/4	10-32	0,010	1/8
0,500	0,375	0,375	0,250	5/8	1/4	10-32	0,010	1/8
0,562	0,375	0,375	0,250	5/8	1/4	10-32	0,010	1/8
0,625	0,4375	0,437	0,375	3/4	5/16	1/4-28	0,015	1/8
0,687	0,4375	0,437	0,375	3/4	5/16	1/4-28	0,015	1/8
0,750	0,500	0,500	0,500	7/8	3/8	3/8-24	0,015	3/16
0,875	0,500	0,500	0,500	7/8	3/8	3/8-24	0,015	3/16
1,000	0,625	0,500	0,625	1	1/2	7/16-20	0,030	3/16
1,125	0,625	0,500	0,625	1	1/2	7/16-20	0,030	3/16
1,250	0,750	0,625	0,687	1 1/4	5/8	1/2-20	0,030	3/16
1,500	0,875	0,750	0,875	1 1/2	3/4	5/8-18	0,030	3/16
1,625	0,875	0,750	0,875	1 1/2	3/4	5/8-18	0,030	3/16
1,750	1,000	0,875	1,000	1 3/4	7/8	3/4-16	0,030	3/16
1,875	1,000	0,875	1,000	1 3/4	7/8	3/4-16	0,030	3/16
2,000	1,250	1,000	1,187	2	1	7/8-14	0,030	3/16
2,250	1,250	1,000	1,187	2	1	7/8-14	0,030	3/16
2,500	1,500	1,125	1,375	2 1/4	1 1/8	1-14	0,030	3/16
2,750	1,500	1,125	1,375	2 1/4	1 1/8	1-14	0,030	3/16
3,000	1,750	1,250	1,750	2 1/2	1 1/4	1 1/4-12	0,060	1/4
3,250	1,750	1,250	1,750	2 1/2	1 1/4	1 1/4-12	0,060	1/4
3,500	2,000	1,375	1,812	2 3/4	1 3/8	1 3/8-12	0,060	1/4
4,000	2,250	2,000	2,000	3 1/2	1 1/2	1 1/2-12	0,060	1/4



TORRINGTON	Designation/Type			Recom. clamping torque (lbs-inch)	Load Rating Static (lbs)	Load Rating Dynamic (lbs)	Weight (kg) approx.
	RBC	ZEN	SMITH				
CRSCE-22	-	CCFE-1 3/8-S	CR-1 3/8-XEC	350	4250	3930	0.16 kg
-	-	CCFE-1/2-N-S	CR-1/2-A-XEC	15	720	620	0.02 kg
CRSCE-8-1	-	CCFE-1/2-S	CR-1/2-XEC	15	790	680	0.02 kg
-	-	CCFE-9/16-S	CR-9/16-XEC	15	790	680	0.02 kg
CRSCE-10-1	-	CCFE-5/8-S	CR-5/8-XEC	35	1215	955	0.02 kg
-	-	CCFE-11/16-S	CR-11/16-XEC	35	1215	955	0.03 kg
CRSCE-12	-	CCFE-3/4-S	CR-3/4-XEC	95	2065	1660	0.03 kg
CRSCE-14	-	CCFE-7/8-S	CR-7/8-XEC	95	2065	1660	0.04 kg
CRSCE-16	-	CCFE-1-S	CR-1-XEC	250	3060	2225	0.08 kg
CRSCE-18	-	CCFE-1 1/8-S	CR-1 1/8-XEC	250	3060	2225	0.09 kg
CRSCE-20	-	CCFE-1 1/4-S	CR-1 1/4-XEC	350	4250	3930	0.14 kg
CRSCE-24	-	CCFE-1 1/2-S	CR-1 1/2-XEC	650	5640	4840	0.24 kg
CRSCE-26	-	CCFE-1 5/8-S	CR-1 5/8-XEC	650	5640	4840	0.27 kg
CRSCE-28	-	CCFE-1 3/4-S	CR-1 3/4-XEC	1250	7920	6385	0.38 kg
CRSCE-30	-	CCFE-1 7/8-S	CR-1 7/8-XEC	1250	7920	6385	0.43 kg
CRSCE-32	-	CCFE-2-S	CR-2-XEC	1500	10570	8090	0.62 kg
CRSCE-36	-	CCFE-2 1/4-S	CR-2 1/4-XEC	1500	10570	8090	0.75 kg
CRSCE-40	-	CCFE-2 1/2-S	CR-2 1/2-XEC	2250	16450	11720	1.13 kg
CRSCE-44	-	CCFE-2 3/4-S	CR-2 3/4-XEC	2250	16450	11720	1.33 kg
CRSCE-48	-	CCFE-3-S	CR-3-XEC	3450	24910	15720	1.91 kg
CRSCE-52	-	CCFE-3 1/4-S	CR-3 1/4-XEC	3450	24910	15720	2.18 kg
CRSCE-56	-	CCFE-3 1/2-S	CR-3 1/2-XEC	4200	31625	22800	2.91 kg
CRSCE-64	-	CCFE-4-S	CR-4-XEC	5000	44770	29985	4.29 kg

Galets de came avec axe CCFE...SB

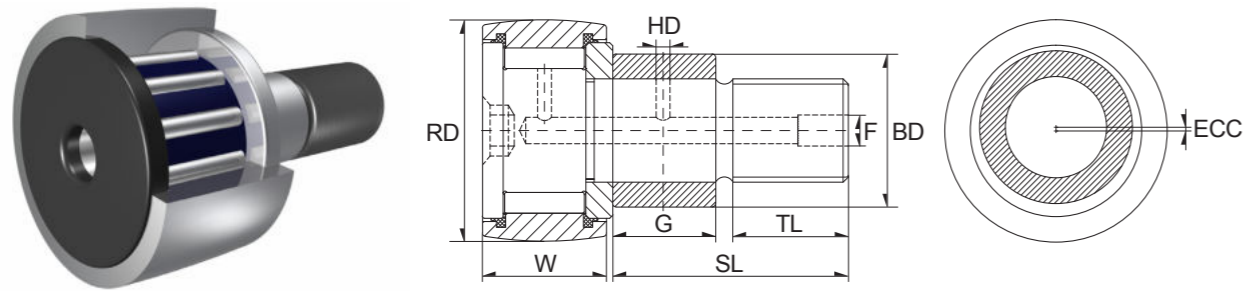

Dimension (inch)								
RD	W	G	BD	SL	TL	FINE THR'DS	EEC	F
0,375	0,750	0,625	0,687	1 1/4	5/8	1/2-20	0,030	3/16
0,500	0,344	0,250	0,250	1/2	1/4	10-32	0,010	-
0,500	0,375	0,375	0,250	5/8	1/4	10-32	0,010	-
0,562	0,375	0,375	0,250	5/8	1/4	10-32	0,010	-
0,625	0,4375	0,437	0,375	3/4	5/16	1/4-28	0,015	-
0,687	0,4375	0,437	0,375	3/4	5/16	1/4-28	0,015	-
0,750	0,500	0,500	0,500	7/8	3/8	3/8-24	0,015	3/16
0,875	0,500	0,500	0,500	7/8	3/8	3/8-24	0,015	3/16
1,000	0,625	0,500	0,625	1	1/2	7/16-20	0,030	3/16
1,125	0,625	0,500	0,625	1	1/2	7/16-20	0,030	3/16
1,250	0,750	0,625	0,687	1 1/4	5/8	1/2-20	0,030	3/16
1,500	0,875	0,750	0,875	1 1/2	3/4	5/8-18	0,030	3/16
1,625	0,875	0,750	0,875	1 1/2	3/4	5/8-18	0,030	3/16
1,750	1,000	0,875	1,000	1 3/4	7/8	3/4-16	0,030	3/16
1,875	1,000	0,875	1,000	1 3/4	7/8	3/4-16	0,030	3/16
2,000	1,250	1,000	1,187	2	1	7/8-14	0,030	3/16
2,250	1,250	1,000	1,187	2	1	7/8-14	0,030	3/16
2,500	1,500	1,125	1,375	2 1/4	1 1/8	1-14	0,030	3/16
2,750	1,500	1,125	1,375	2 1/4	1 1/8	1-14	0,030	3/16
3,000	1,750	1,250	1,750	2 1/2	1 1/4	1 1/4-12	0,060	1/4
3,250	1,750	1,250	1,750	2 1/2	1 1/4	1 1/4-12	0,060	1/4
3,500	2,000	1,375	1,812	2 3/4	1 3/8	1 3/8-12	0,060	1/4
4,000	2,250	2,000	2,000	3 1/2	1 1/2	1 1/2-12	0,060	1/4



Designation/Type				Recom. clamping torque (lbs-inch)	Load Rating Static (lbs)	Load Rating Dynamic (lbs)	Weight (kg) approx.
TORRINGTON	RBC	ZEN	SMITH				
CRSBCE-22	CS-44-LWX	CCFE-1 3/8-SB	CR-1 3/8-XBEC	350	4250	3930	0.16 kg
-	-	CCFE-1/2-N-SB	CR-1/2-A-XBEC	15	720	620	0.02 kg
CRSBCE-8-1	CS-16-LWX	CCFE-1/2-SB	CR-1/2-XBEC	15	790	680	0.02 kg
-	CS-18-LWX	CCFE-9/16-SB	CR-9/16-XBEC	15	790	680	0.02 kg
CRSBCE-10-1	CS-20-LWX	CCFE-5/8-SB	CR-5/8-XBEC	35	1215	955	0.02 kg
-	CS-22-LWX	CCFE-11/16-SB	CR-11/16-XBEC	35	1215	955	0.03 kg
CRSBCE-12	CS-24-LWX	CCFE-3/4-SB	CR-3/4-XBEC	95	2065	1660	0.03 kg
CRSBCE-14	CS-28-LWX	CCFE-7/8-SB	CR-7/8-XBEC	95	2065	1660	0.04 kg
CRSBCE-16	CS-32-LWX	CCFE-1-SB	CR-1-XBEC	250	3060	2225	0.08 kg
CRSBCE-18	CS-36-LWX	CCFE-1 1/8-SB	CR-1 1/8-XBEC	250	3060	2225	0.09 kg
CRSBCE-20	CS-40-LWX	CCFE-1 1/4-SB	CR-1 1/4-XBEC	350	4250	3930	0.14 kg
CRSBCE-24	CS-48-LWX	CCFE-1 1/2-SB	CR-1 1/2-XBEC	650	5640	4840	0.24 kg
CRSBCE-26	CS-52-LWX	CCFE-1 5/8-SB	CR-1 5/8-XBEC	650	5640	4840	0.27 kg
CRSBCE-28	CS-56-LWX	CCFE-1 3/4-SB	CR-1 3/4-XBEC	1250	7920	6385	0.38 kg
CRSBCE-30	CS-60-LWX	CCFE-1 7/8-SB	CR-1 7/8-XBEC	1250	7920	6385	0.43 kg
CRSBCE-32	CS-64-LWX	CCFE-2-SB	CR-2-XBEC	1500	10570	8090	0.62 kg
CRSBCE-36	CS-72-LWX	CCFE-2 1/4-SB	CR-2 1/4-XBEC	1500	10570	8090	0.75 kg
CRSBCE-40	CS-80-LWX	CCFE-2 1/2-SB	CR-2 1/2-XBEC	2250	16450	11720	1.13 kg
CRSBCE-44	CS-88-LWX	CCFE-2 3/4-SB	CR-2 3/4-XBEC	2250	16450	11720	1.33 kg
CRSBCE-48	CS-96-LWX	CCFE-3-SB	CR-3-XBEC	3450	24910	15720	1.91 kg
CRSBCE-52	CS-104-LWX	CCFE-3 1/4-SB	CR-3 1/4-XBEC	3450	24910	15720	2.20 kg
CRSBCE-56	CS-112-LWX	CCFE-3 1/2-SB	CR-3 1/2-XBEC	4200	31625	22800	2.91 kg
CRSBCE-64	CS-128-LWX	CCFE-4-SB	CR-4-XBEC	5000	44770	29985	4.29 kg

Galets de came avec axe CFH & CFH...S

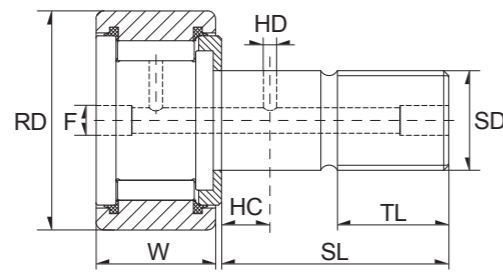
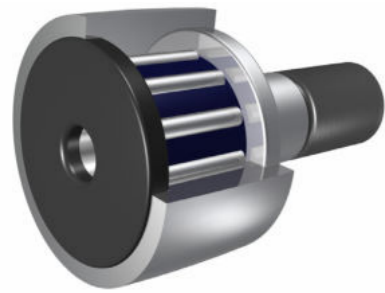

Dimension (inch)								
RD	W	SD	SL	TL	FINE THR'DS	HC	HD	F
0,500	0,375	0,250	5/8	1/4	1/4-28	-	-	1/8
0,500	0,375	0,250	5/8	1/4	1/4-28	-	-	1/8
0,562	0,375	0,250	5/8	1/4	1/4-28	-	-	1/8
0,562	0,375	0,250	5/8	1/4	1/4-28	-	-	1/8
0,625	0,4375	0,3125	3/4	5/16	5/16-24	-	-	1/8
0,625	0,4375	0,3125	3/4	5/16	5/16-24	-	-	1/8
0,687	0,4375	0,3125	3/4	5/16	5/16-24	-	-	1/8
0,687	0,4375	0,3125	3/4	5/16	5/16-24	-	-	1/8
0,750	0,500	0,4375	7/8	3/8	7/16-20	1/4	3/32	3/16
0,750	0,500	0,4375	7/8	3/8	7/16-20	1/4	3/32	3/16
0,875	0,500	0,4375	7/8	3/8	7/16-20	1/4	3/32	3/16
0,875	0,500	0,4375	7/8	3/8	7/16-20	1/4	3/32	3/16
1,000	0,625	0,625	1	1/2	5/8-18	1/4	3/32	3/16
1,000	0,625	0,625	1	1/2	5/8-18	1/4	3/32	3/16
1,125	0,625	0,625	1	1/2	5/8-18	1/4	3/32	3/16
1,125	0,625	0,625	1	1/2	5/8-18	1/4	3/32	3/16
1,250	0,750	0,750	1 1/4	5/8	3/4-16	5/16	3/32	3/16
1,250	0,750	0,750	1 1/4	5/8	3/4-16	5/16	3/32	3/16
1,375	0,750	0,750	1 1/4	5/8	3/4-16	5/16	3/32	3/16
1,375	0,750	0,750	1 1/4	5/8	3/4-16	5/16	3/32	3/16
1,500	0,875	0,875	1 1/2	3/4	7/8-14	3/8	3/32	3/16
1,500	0,875	0,875	1 1/2	3/4	7/8-14	3/8	3/32	3/16
1,625	0,875	0,875	1 1/2	3/4	7/8-14	3/8	3/32	3/16
1,625	0,875	0,875	1 1/2	3/4	7/8-14	3/8	3/32	3/16
1,750	1,000	1,000	1 3/4	7/8	1-14	7/16	3/32	3/16
1,750	1,000	1,000	1 3/4	7/8	1-14	7/16	3/32	3/16
1,875	1,000	1,000	1 3/4	7/8	1-14	7/16	3/32	3/16
1,875	1,000	1,000	1 3/4	7/8	1-14	7/16	3/32	3/16
2,000	1,250	1,125	2	1	1 1/8-12	1/2	1/8	3/16
2,000	1,250	1,125	2	1	1 1/8-12	1/2	1/8	3/16



Designation/Type				Recom. clamping torque (lbs-inch)	Load Rating Static (lbs)	Load Rating Dynamic (lbs)	Weight (kg) approx.
TORRINGTON	RBC	ZEN	SMITH				
CRH-8-1	-	CFH-1/2	HR-1/2	35	1580	680	0.18 kg
CRHS-8-1	-	CFH-1/2-S	HR-1/2-X	35	1580	680	0.02 kg
-	-	CFH-9/16	HR-9/16	35	1580	680	0.02 kg
-	-	CFH-9/16-S	HR-9/16-X	35	1580	680	0.02 kg
CRH-10-1	-	CFH-5/8	HR-5/8	90	2480	955	0.02 kg
CRHS-10-1	-	CFH-5/8-S	HR-5/8-X	90	2480	955	0.02 kg
-	-	CFH-11/16	HR-11/16	90	2480	955	0.03 kg
-	-	CFH-11/16-S	HR-11/16-X	90	2480	955	0.03 kg
CRH-12	H-24	CFH-3/4	HR-3/4	250	4130	1660	0.04 kg
CRHS-12	H-24-L	CFH-3/4-S	HR-3/4-X	250	4130	1660	0.04 kg
CRH-14	H-28	CFH-7/8	HR-7/8	250	4130	1660	0.05 kg
CRHS-14	H-28-L	CFH-7/8-S	HR-7/8-X	250	4130	1660	0.05 kg
CRH-16	H-32	CFH-1	HR-1	650	6120	2225	0.09 kg
CRHS-16	H-32-L	CFH-1-S	HR-1-X	650	6120	2225	0.09 kg
CRH-18	H-36	CFH-1 1/8	HR-1 1/8	650	6120	2225	0.09 kg
CRHS-18	H-36-L	CFH-1 1/8-S	HR-1 1/8-X	650	6120	2225	0.09 kg
CRH-20	H-40	CFH-1 1/4	HR-1 1/4	1250	8500	3930	0.17 kg
CRHS-20	H-40-L	CFH-1 1/4-S	HR-1 1/4-X	1250	8500	3930	0.17 kg
CRH-22	H-44	CFH-1 3/8	HR-1 3/8	1250	8500	3930	0.20 kg
CRHS-22	H-44-L	CFH-1 3/8-S	HR-1 3/8-X	1250	8500	3930	0.20 kg
CRH-24	H-48	CFH-1 1/2	HR-1 1/2	1500	11280	4840	0.31 kg
CRHS-24	H-48-L	CFH-1 1/2-S	HR-1 1/2-X	1500	11280	4840	0.31 kg
CRH-26	H-52	CFH-1 5/8	HR-1 5/8	1500	11280	4840	0.34 kg
CRHS-26	H-52-L	CFH-1 5/8-S	HR-1 5/8-X	1500	11280	4840	0.34 kg
CRH-28	H-56	CFH-1 3/4	HR-1 3/4	2250	15840	6385	0.45 kg
CRHS-28	H-56-L	CFH-1 3/4-S	HR-1 3/4-X	2250	15840	6385	0.45 kg
CRH-30	H-60	CFH-1 7/8	HR-1 7/8	2250	15840	6385	0.52 kg
CRHS-30	H-60-L	CFH-1 7/8-S	HR-1 7/8-X	2250	15840	6385	0.52 kg
CRH-32	H-64	CFH-2	HR-2	2800	21140	8090	1.71 kg
CRHS-32	H-64-L	CFH-2-S	HR-2-X	2800	21140	8090	1.71 kg

Galets de came avec axe CFH & CFH...S

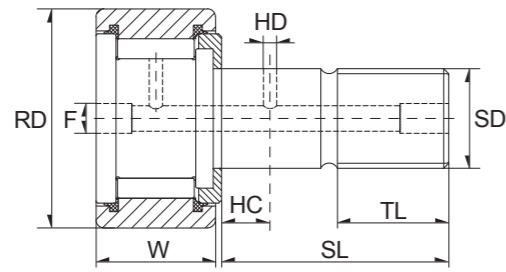
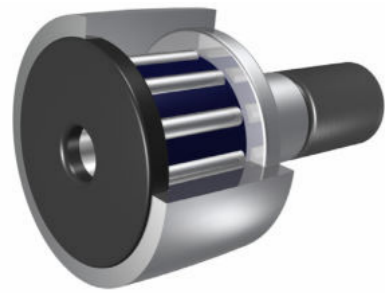

Dimension (inch)								
RD	W	SD	SL	TL	FINE THR'DS	HC	HD	F
2,250	1,250	1,125	2	1	1 1/8-12	1/2	1/8	3/16
2,250	1,250	1,125	2	1	1 1/8-12	1/2	1/8	3/16
2,500	1,500	1,250	2 1/4	1 1/8	1 1/4-12	9/16	1/8	3/16
2,500	1,500	1,250	2 1/4	1 1/8	1 1/4-12	9/16	1/8	3/16
2,750	1,500	1,250	2 1/4	1 1/8	1 1/4-12	9/16	1/8	3/16
2,750	1,500	1,250	2 1/4	1 1/8	1 1/4-12	9/16	1/8	3/16
3,000	1,750	1,500	2 1/2	1 1/4	1 1/2-12	5/8	1/8	1/4
3,000	1,750	1,500	2 1/2	1 1/4	1 1/2-12	5/8	1/8	1/4
3,250	1,750	1,500	2 1/2	1 1/4	1 1/2-12	5/8	1/8	1/4
3,250	1,750	1,500	2 1/2	1 1/4	1 1/2-12	5/8	1/8	1/4
3,500	2,000	1,750	2 3/4	1 3/8	1 3/4-12	11/16	1/8	1/4
3,500	2,000	1,750	2 3/4	1 3/8	1 3/4-12	11/16	1/8	1/4
4,000	2,250	2,000	3 1/2	1 1/2	2-12	3/4	1/8	1/4
4,000	2,250	2,000	3 1/2	1 1/2	2-12	3/4	1/8	1/4
5,000	2,750	2,500	5 1/16	2 9/16	2 1/2-12	7/8	3/16	1/4
6,000	3,250	3,000	6	3	3-12	1	3/16	1/4
7,000	3,500	3,500	7 11/16	4 1/8	3 1/2-4	1 1/4	3/16	1/4



Designation/Type				Recom. clamping torque (lbs-inch)	Load Rating Static (lbs)	Load Rating Dynamic (lbs)	Weight (kg) approx.
TORRINGTON	RBC	ZEN	SMITH				
CRH-36	H-72	CFH-2 1/4	HR-2 1/4	2800	21140	8090	0.85 kg
CRHS-36	H-72-L	CFH-2 1/4-S	HR-2 1/4-X	2800	21140	8090	0.85 kg
CRH-40	H-80	CFH-2 1/2	HR-2 1/2	3450	32900	11720	1.25 kg
CRHS-40	H-80-L	CFH-2 1/2-S	HR-2 1/2-X	3450	32900	11720	1.25 kg
CRH-44	H-88	CFH-2 3/4	HR-2 3/4	3450	32900	11720	1.45 kg
CRHS-44	H-88-L	CFH-2 3/4-S	HR-2 3/4-X	3450	32900	11720	1.45 kg
CRH-48	H-96	CFH-3	HR-3	5000	49820	15720	2.07 kg
CRHS-48	H-96-L	CFH-3-S	HR-3-X	5000	49820	15720	2.07 kg
CRH-52	H-104	CFH-3 1/4	HR-3 1/4	5000	49820	15720	2.35 kg
CRHS-52	H-104-L	CFH-3 1/4-S	HR-3 1/4-X	5000	49820	15720	2.35 kg
CRH-56	H-112	CFH-3 1/2	HR-3 1/2	5000	663250	22800	3.18 kg
CRHS-56	H-112-L	CFH-3 1/2-S	HR-3 1/2-X	5000	663250	22800	3.18 kg
CRH-64	H-128	CFH-4	HR-4	5000	89540	29985	4.91 kg
CRHS-64	H-128-L	CFH-4-S	HR-4-X	5000	89540	29985	4.91 kg
-	-	CFH-5-S	HR-5-X	5000	135900	46575	10.02 kg
-	-	CFH-6-S	HR-6-X	5000	160900	60000	16.52 kg
-	-	CFH-7-S	HR-7-X	5000	213860	75380	30.86 kg

Galets de came avec axe CFH...B & CFH...SB

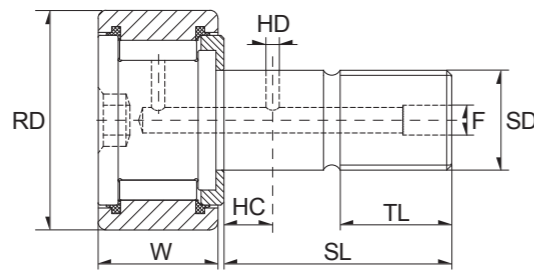
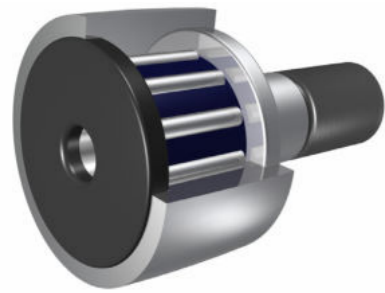

Dimension (inch)								
RD	W	SD	SL	TL	FINE THR'DS	HC	HD	F
0,500	0,375	0,250	5/8	1/4	1/4-28	-	-	-
0,500	0,375	0,250	5/8	1/4	1/4-28	-	-	-
0,562	0,375	0,250	5/8	1/4	1/4-28	-	-	-
0,562	0,375	0,250	5/8	1/4	1/4-28	-	-	-
0,625	0,4375	0,3125	3/4	5/16	5/16-24	-	-	-
0,625	0,4375	0,3125	3/4	5/16	5/16-24	-	-	-
0,687	0,4375	0,3125	3/4	5/16	5/16-24	-	-	-
0,687	0,4375	0,3125	3/4	5/16	5/16-24	-	-	-
0,750	0,500	0,4375	7/8	3/8	7/16-20	1/4	3/32	3/16
0,750	0,500	0,4375	7/8	3/8	7/16-20	1/4	3/32	3/16
0,875	0,500	0,4375	7/8	3/8	7/16-20	1/4	3/32	3/16
0,875	0,500	0,4375	7/8	3/8	7/16-20	1/4	3/32	3/16
1,000	0,625	0,625	1	1/2	5/8-18	1/4	3/32	3/16
1,000	0,625	0,625	1	1/2	5/8-18	1/4	3/32	3/16
1,125	0,625	0,625	1	1/2	5/8-18	1/4	3/32	3/16
1,125	0,625	0,625	1	1/2	5/8-18	1/4	3/32	3/16
1,250	0,750	0,750	1 1/4	5/8	3/4-16	5/16	3/32	3/16
1,250	0,750	0,750	1 1/4	5/8	3/4-16	5/16	3/32	3/16
1,375	0,750	0,750	1 1/4	5/8	3/4-16	5/16	3/32	3/16
1,375	0,750	0,750	1 1/4	5/8	3/4-16	5/16	3/32	3/16
1,500	0,875	0,875	1 1/2	3/4	7/8-14	3/8	3/32	3/16
1,500	0,875	0,875	1 1/2	3/4	7/8-14	3/8	3/32	3/16
1,625	0,875	0,875	1 1/2	3/4	7/8-14	3/8	3/32	3/16
1,625	0,875	0,875	1 1/2	3/4	7/8-14	3/8	3/32	3/16
1,750	1,000	1,000	1 3/4	7/8	1-14	7/16	3/32	3/16
1,750	1,000	1,000	1 3/4	7/8	1-14	7/16	3/32	3/16
1,875	1,000	1,000	1 3/4	7/8	1-14	7/16	3/32	3/16
1,875	1,000	1,000	1 3/4	7/8	1-14	7/16	3/32	3/16
2,000	1,250	1,125	2	1	1 1/8-12	1/2	1/8	3/16
2,000	1,250	1,125	2	1	1 1/8-12	1/2	1/8	3/16



Designation/Type				Recom. clamping torque (lbs-inch)	Load Rating Static (lbs)	Load Rating Dynamic (lbs)	Weight (kg) approx.
TORRINGTON	RBC	ZEN	SMITH				
CRHB-8-1	-	CFH-1/2-B	HR-1/2-B	35	1580	680	0.02 kg
CRHSB-8-1	H-16-LW	CFH-1/2-SB	HR-1/2-XB	35	1580	680	0.02 kg
-	-	CFH-9/16-B	HR-9/16-B	35	1580	680	0.02 kg
-	H-18-LW	CFH-9/16-SB	HR-9/16-XB	35	1580	680	0.02 kg
CRHB-10-1	-	CFH-5/8-B	HR-5/8-B	90	2480	955	0.02 kg
CRHSB-10-1	H-20-LW	CFH-5/8-SB	HR-5/8-XB	90	2480	955	0.02 kg
-	-	CFH-11/16-B	HR-11/16-B	90	2480	955	0.03 kg
-	H-22-LW	CFH-11/16-SB	HR-11/16-XB	90	2480	955	0.03 kg
CRHB-12	-	CFH-3/4-B	HR-3/4-B	250	4130	1660	0.04 kg
CRHSB-12	H-24-LW	CFH-3/4-SB	HR-3/4-XB	250	4130	1660	0.04 kg
CRHB-14	-	CFH-7/8-B	HR-7/8-B	250	4130	1660	0.05 kg
CRHSB-14	H-28-LW	CFH-7/8-SB	HR-7/8-XB	250	4130	1660	0.05 kg
CRHB-16	-	CFH-1-B	HR-1-B	650	6120	2225	0.09 kg
CRHSB-16	H-32-LW	CFH-1-SB	HR-1-XB	650	6120	2225	0.09 kg
CRHB-18	-	CFH-1 1/8-B	HR-1 1/8-B	650	6120	2225	0.09 kg
CRHSB-18	H-36-LW	CFH-1 1/8-SB	HR-1 1/8-XB	650	6120	2225	0.09 kg
CRHB-20	-	CFH-1 1/4-B	HR-1 1/4-B	1250	8500	3930	0.17 kg
CRHSB-20	H-40-LW	CFH-1 1/4-SB	HR-1 1/4-XB	1250	8500	3930	0.17 kg
CRHB-22	-	CFH-1 3/8-B	HR-1 3/8-B	1250	8500	3930	0.20 kg
CRHSB-22	H-44-LW	CFH-1 3/8-SB	HR-1 3/8-XB	1250	8500	3930	0.20 kg
CRHB-24	-	CFH-1 1/2-B	HR-1 1/2-B	1500	11280	4840	0.31 kg
CRHSB-24	H-48-LW	CFH-1 1/2-SB	HR-1 1/2-XB	1500	11280	4840	0.31 kg
CRHB-26	-	CFH-1 5/8-B	HR-1 5/8-B	1500	11280	4840	0.34 kg
CRHSB-26	H-52-LW	CFH-1 5/8-SB	HR-1 5/8-XB	1500	11280	4840	0.34 kg
CRHB-28	-	CFH-1 3/4-B	HR-1 3/4-B	2250	15840	6385	0.45 kg
CRHSB-28	H-56-LW	CFH-1 3/4-SB	HR-1 3/4-XB	2250	15840	6385	0.45 kg
CRHB-30	-	CFH-1 7/8-B	HR-1 7/8-B	2250	15840	6385	0.52 kg
CRHSB-30	H-60-LW	CFH-1 7/8-SB	HR-1 7/8-XB	2250	15840	6385	0.52 kg
CRHB-32	-	CFH-2-B	HR-2-B	2800	21140	8090	0.71 kg
CRHSB-32	H-64-LW	CFH-2-SB	HR-2-XB	2800	21140	8090	0.71 kg

Galets de came avec axe CFH...B & CFH...SB

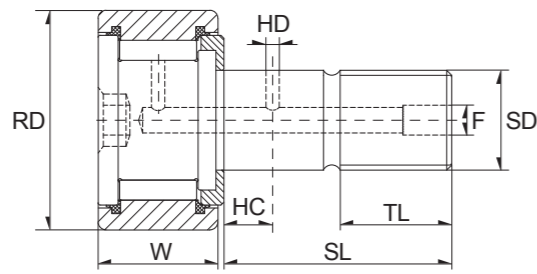
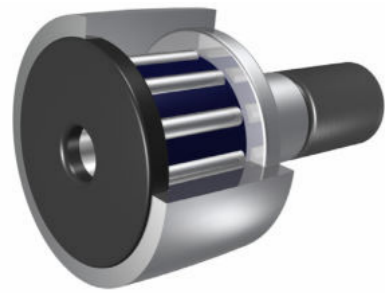

Dimension (inch)								
RD	W	SD	SL	TL	FINE THR'DS	HC	HD	F
2,250	1,250	1,125	2	1	1 1/8-12	1/2	1/8	3/16
2,250	1,250	1,125	2	1	1 1/8-12	1/2	1/8	3/16
2,500	1,500	1,250	2 1/4	1 1/8	1 1/4-12	9/16	1/8	3/16
2,500	1,500	1,250	2 1/4	1 1/8	1 1/4-12	9/16	1/8	3/16
2,750	1,500	1,250	2 1/4	1 1/8	1 1/4-12	9/16	1/8	3/16
2,750	1,500	1,250	2 1/4	1 1/8	1 1/4-12	9/16	1/8	3/16
3,000	1,750	1,500	2 1/2	1 1/4	1 1/2-12	5/8	1/8	1/4
3,000	1,750	1,500	2 1/2	1 1/4	1 1/2-12	5/8	1/8	1/4
3,250	1,750	1,500	2 1/2	1 1/4	1 1/2-12	5/8	1/8	1/4
3,250	1,750	1,500	2 1/2	1 1/4	1 1/2-12	5/8	1/8	1/4
3,500	2,000	1,750	2 3/4	1 3/8	1 3/4-12	11/16	1/8	1/4
3,500	2,000	1,750	2 3/4	1 3/8	1 3/4-12	11/16	1/8	1/4
4,000	2,250	2,000	3 1/2	1 1/2	2-12	3/4	1/8	1/4
4,000	2,250	2,000	3 1/2	1 1/2	2-12	3/4	1/8	1/4



TORRINGTON	Designation/Type			Recom. clamping torque (lbs-inch)	Load Rating Static (lbs)	Load Rating Dynamic (lbs)	Weight (kg) approx.
	RBC	ZEN	SMITH				
CRHB-36	-	CFH-2 1/4-B	HR-2 1/4-B	2800	21140	8090	0.85 kg
CRHSB-36	H-72-LW	CFH-2 1/4-SB	HR-2 1/4-XB	2800	21140	8090	0.85 kg
CRHB-40	-	CFH-2 1/2-B	HR-2 1/2-B	3450	32900	11720	1.25 kg
CRHSB-40	H-80-LW	CFH-2 1/2-SB	HR-2 1/2-XB	3450	32900	11720	1.25 kg
CRHB-44	-	CFH-2 3/4-B	HR-2 3/4-B	3450	32900	11720	1.45 kg
CRHSB-44	H-88-LW	CFH-2 3/4-SB	HR-2 3/4-XB	3450	32900	11720	1.45 kg
CRHB-48	-	CFH-3-B	HR-3-B	5000	49820	15720	2.07 kg
CRHSB-48	H-96-LW	CFH-3-SB	HR-3-XB	5000	49820	15720	2.07 kg
CRHB-52	-	CFH-3 1/4-B	HR-3 1/4-B	5000	49820	15720	2.35 kg
CRHSB-52	H-104-LW	CFH-3 1/4-SB	HR-3 1/4-XB	5000	49820	15720	2.35 kg
CRHB-56	-	CFH-3 1/2-B	HR-3 1/2-B	5000	63250	22800	3.18 kg
CRHSB-56	H-112-LW	CFH-3 1/2-SB	HR-3 1/2-XB	5000	63250	22800	3.18 kg
CRHB-64	-	CFH-4-B	HR-4-B	5000	89540	29985	4.91 kg
CRHSB-64	H-128-LW	CFH-4-SB	HR-4-XB	5000	89540	29985	4.91 kg

Galets de came avec axe CCFH...S

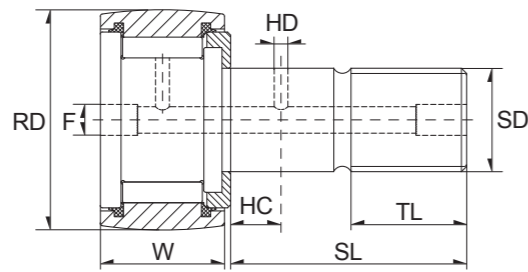
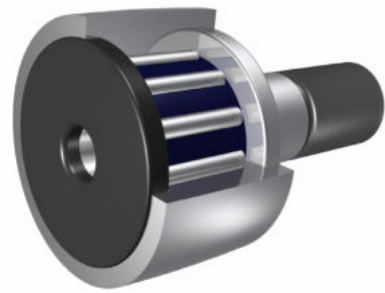

Dimension (inch)								
RD	W	SD	SL	TL	FINE THR'DS	HC	HD	F
0,500	0,375	0,250	5/8	1/4	1/4-28	-	-	1/8
0,562	0,375	0,250	5/8	1/4	1/4-28	-	-	1/8
0,625	0,4375	0,3125	3/4	5/16	5/16-24	-	-	1/8
0,687	0,4375	0,3125	3/4	5/16	5/16-24	-	-	1/8
0,750	0,500	0,4375	7/8	3/8	7/16-20	1/4	3/32	3/16
0,875	0,500	0,4375	7/8	3/8	7/16-20	1/4	3/32	3/16
1,000	0,625	0,625	1	1/2	5/8-18	1/4	3/32	3/16
1,125	0,625	0,625	1	1/2	5/8-18	1/4	3/32	3/16
1,250	0,750	0,750	1 1/4	5/8	3/4-16	5/16	3/32	3/16
1,375	0,750	0,750	1 1/4	5/8	3/4-16	5/16	3/32	3/16
1,500	0,875	0,875	1 1/2	3/4	7/8-14	3/8	3/32	3/16
1,625	0,875	0,875	1 1/2	3/4	7/8-14	3/8	3/32	3/16
1,750	1,000	1,000	1 3/4	7/8	1-14	7/16	3/32	3/16
1,875	1,000	1,000	1 3/4	7/8	1-14	7/16	3/32	3/16
2,000	1,250	1,125	2	1	1 1/8-12	1/2	1/8	3/16
2,250	1,250	1,125	2	1	1 1/8-12	1/2	1/8	3/16
2,500	1,500	1,250	2 1/4	1 1/8	1 1/4-12	9/16	1/8	3/16
2,750	1,500	1,250	2 1/4	1 1/8	1 1/4-12	9/16	1/8	3/16
3,000	1,750	1,500	2 1/2	1 1/4	1 1/2-12	5/8	1/8	1/4
3,250	1,750	1,500	2 1/2	1 1/4	1 1/2-12	5/8	1/8	1/4
3,500	2,000	1,750	2 3/4	1 3/8	1 3/4-12	11/16	1/8	1/4
4,000	2,250	2,000	3 1/2	1 1/2	2-12	3/4	1/8	1/4
5,000	2,750	2,500	5 11/16	2 9/16	2 1/2-12	7/8	3/16	1/4
6,000	3,250	3,000	6	3	3-12	1	3/16	1/4
7,000	3,750	3,500	7 11/16	4 1/8	3 1/2-4	1 1/4	3/16	1/4



Designation/Type				Recom. clamping torque (lbs-inch)	Load Rating Static (lbs)	Load Rating Dynamic (lbs)	Weight (kg) approx.
TORRINGTON	RBC	ZEN	SMITH				
CRHSC-8-1	-	CCFH-1/2-S	HR-1/2-XC	35	1580	680	0.02 kg
-	-	CCFH-9/16-S	HR-9/16-XC	35	1580	680	0.02 kg
CRHSC-10-1	-	CCFH-5/8-S	HR-5/8-XC	90	2480	955	0.02 kg
-	-	CCFH-11/16-S	HR-11/16-XC	90	2480	955	0.03 kg
CRHSC-12	CH-24-L	CCFH-3/4-S	HR-3/4-XC	250	4130	1660	0.04 kg
CRHSC-14	CH-28-L	CCFH-7/8-S	HR-7/8-XC	250	4130	1660	0.05 kg
CRHSC-16	CH-32-L	CCFH-1-S	HR-1-XC	650	6120	2225	0.09 kg
CRHSC-18	CH-36-L	CCFH-1 1/8-S	HR-1 1/8-XC	650	6120	2225	0.09 kg
CRHSC-20	CH-40-L	CCFH-1 1/4-S	HR-1 1/4-XC	1250	8500	3930	0.17 kg
CRHSC-22	CH-44-L	CCFH-1 3/8-S	HR-1 3/8-XC	1250	8500	3930	0.20 kg
CRHSC-24	CH-48-L	CCFH-1 1/2-S	HR-1 1/2-XC	1500	11280	4840	0.31 kg
CRHSC-26	CH-52-L	CCFH-1 5/8-S	HR-1 5/8-XC	1500	11280	4840	0.34 kg
CRHSC-28	CH-56-L	CCFH-1 3/4-S	HR-1 3/4-XC	2250	15840	6385	0.45 kg
CRHSC-30	CH-60-L	CCFH-1 7/8-S	HR-1 7/8-XC	2250	15840	6385	0.52 kg
CRHSC-32	CH-64-L	CCFH-2-S	HR-2-XC	2800	21140	8090	0.71 kg
CRHSC-36	CH-72-L	CCFH-2 1/4-S	HR-2 1/4-XC	2800	21140	8090	0.85 kg
CRHSC-40	CH-80-L	CCFH-2 1/2-S	HR-2 1/2-XC	3450	32900	11720	1.25 kg
CRHSC-44	CH-88-L	CCFH-2 3/4-S	HR-2 3/4-XC	3450	32900	11720	1.45 kg
CRHSC-48	CH-96-L	CCFH-3-S	HR-3-XC	5000	49820	15720	2.07 kg
CRHSC-52	CH-104-L	CCFH-3 1/4-S	HR-3 1/4-XC	5000	49820	15720	2.35 kg
CRHSC-56	CH-112-L	CCFH-3 1/2-S	HR-3 1/2-XC	5000	63250	22800	3.18 kg
CRHSC-64	CH-128-L	CCFH-4-S	HR-4-XC	5000	89540	29985	4.91 kg
-	-	CCFH-5-S	HR-5-XC	5000	135900	46575	10.02 kg
-	-	CCFH-6-S	HR-6-XC	5000	160900	60000	16.52 kg
-	-	CCFH-7-S	HR-7-XC	5000	213860	75380	30.86 kg

Galets de came avec axe CCFH...SB

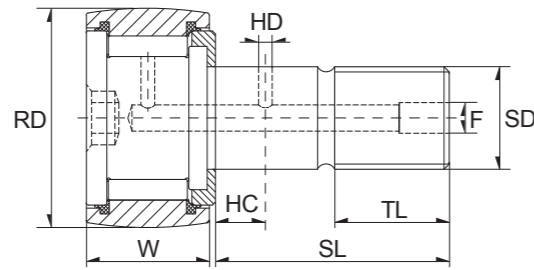
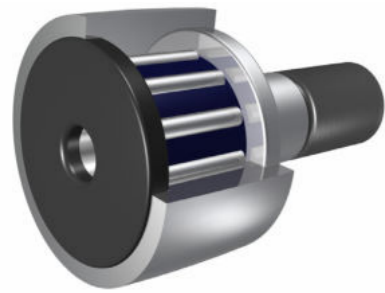

Dimension (inch)								
RD	W	SD	SL	TL	FINE THR'DS	HC	HD	F
0,500	0,375	0,250	5/8	1/4	1/4-28	-	-	-
0,562	0,375	0,250	5/8	1/4	1/4-28	-	-	-
0,625	0,4375	0,3125	3/4	5/16	5/16-24	-	-	-
0,687	0,4375	0,3125	3/4	5/16	5/16-24	-	-	-
0,750	0,500	0,4375	7/8	3/8	7/16-20	1/4	3/32	3/16
0,875	0,500	0,4375	7/8	3/8	7/16-20	1/4	3/32	3/16
1,000	0,625	0,625	1	1/2	5/8-18	1/4	3/32	3/16
1,125	0,625	0,625	1	1/2	5/8-18	1/4	3/32	3/16
1,250	0,750	0,750	1 1/4	5/8	3/4-16	5/16	3/32	3/16
1,375	0,750	0,750	1 1/4	5/8	3/4-16	5/16	3/32	3/16
1,500	0,875	0,875	1 1/2	3/4	7/8-14	3/8	3/32	3/16
1,625	0,875	0,875	1 1/2	3/4	7/8-14	3/8	3/32	3/16
1,750	1,000	1,000	1 3/4	7/8	1-14	7/16	3/32	3/16
1,875	1,000	1,000	1 3/4	7/8	1-14	7/16	3/32	3/16
2,000	1,250	1,125	2	1	1 1/8-12	1/2	1/8	3/16
2,250	1,250	1,125	2	1	1 1/8-12	1/2	1/8	3/16
2,500	1,500	1,250	2 1/4	1 1/8	1 1/4-12	9/16	1/8	3/16
2,750	1,500	1,250	2 1/4	1 1/8	1 1/4-12	9/16	1/8	3/16
3,000	1,750	1,500	2 1/2	1 1/4	1 1/2-12	5/8	1/8	1/4
3,250	1,750	1,500	2 1/2	1 1/4	1 1/2-12	5/8	1/8	1/4
3,500	2,000	1,750	2 3/4	1 3/8	1 3/4-12	11/16	1/8	1/4
4,000	2,250	2,000	3 1/2	1 1/2	2-12	3/4	1/8	1/4



Designation/Type				Recom. clamping torque (lbs-inch)	Load Rating Static (lbs)	Load Rating Dynamic (lbs)	Weight (kg) approx.
TORRINGTON	RBC	ZEN	SMITH				
CRHSBC-8-1	CH-16-LW	CCFH-1/2-SB	HR-1/2-XBC	35	1580	680	0.02 kg
-	CH-18-LW	CCFH-9/16-SB	HR-9/16-XBC	35	1580	680	0.02 kg
CRHSBC-10-1	CH-20-LW	CCFH-5/8-SB	HR-5/8-XBC	90	2480	955	0.02 kg
-	CH-22-LW	CCFH-11/16-SB	HR-11/16-XBC	90	2480	955	0.03 kg
CRHSBC-12	CH-24-LW	CCFH-3/4-SB	HR-3/4-XBC	250	4130	1660	0.04 kg
CRHSBC-14	CH-28-LW	CCFH-7/8-SB	HR-7/8-XBC	250	4130	1660	0.05 kg
CRHSBC-16	CH-32-LW	CCFH-1-SB	HR-1-XBC	650	6120	2225	0.09 kg
CRHSBC-18	CH-36-LW	CCFH-1 1/8-SB	HR-1 1/8-XBC	650	6120	2225	0.09 kg
CRHSBC-20	CH-40-LW	CCFH-1 1/4-SB	HR-1 1/4-XBC	1250	8500	3930	0.17 kg
CRHSBC-22	CH-44-LW	CCFH-1 3/8-SB	HR-1 3/8-XBC	1250	8500	3930	0.20 kg
CRHSBC-24	CH-48-LW	CCFH-1 1/2-SB	HR-1 1/2-XBC	1500	11280	4840	0.31 kg
CRHSBC-26	CH-52-LW	CCFH-1 5/8-SB	HR-1 5/8-XBC	1500	11280	4840	0.34 kg
CRHSBC-28	CH-56-LW	CCFH-1 3/4-SB	HR-1 3/4-XBC	2250	15840	6385	0.45 kg
CRHSBC-30	CH-60-LW	CCFH-1 7/8-SB	HR-1 7/8-XBC	2250	15840	6385	0.52 kg
CRHSBC-32	CH-64-LW	CCFH-2-SB	HR-2-XBC	2800	21140	8090	0.71 kg
CRHSBC-36	CH-72-LW	CCFH-2 1/4-SB	HR-2 1/4-XBC	2800	21140	8090	0.85 kg
CRHSBC-40	CH-80-LW	CCFH-2 1/2-SB	HR-2 1/2-XBC	3450	32900	11720	1.25 kg
CRHSBC-44	CH-88-LW	CCFH-2 3/4-SB	HR-2 3/4-XBC	3450	32900	11720	1.45 kg
CRHSBC-48	CH-96-LW	CCFH-3-SB	HR-3-XBC	5000	49820	15720	2.07 kg
CRHSBC-52	CH-104-LW	CCFH-3 1/4-SB	HR-3 1/4-XBC	5000	49820	15720	2.35 kg
CRHSBC-56	CH-112-LW	CCFH-3 1/2-SB	HR-3 1/2-XBC	5000	63250	22800	3.18 kg
CRHSBC-64	CH-128-LW	CCFH-4-SB	HR-4-XBC	5000	89540	29985	4.91 kg

www.zen.biz

Tous droits réservés.
Aucune partie du catalogue ne
peut être copiée, extraite ou
modifiée sans autorisation explicite
du détenteur du copyright.

v.10 / 18



Bearings for your future