

ZON™

BEARINGS FOR YOUR FUTURE



Gehäuse und Einsätze / Housings and Inserts



TÜVRheinland®
CERT
Certified ISO 2008
Management System
according to ISO 9001:2008



BEARINGS FOR YOUR FUTURE

Zen Ball Bearings are manufactured to the highest quality for standard and non-standard applications. Our technical department can modify any non-standard bearings to your specific requirements, regardless of quantity.

Apart from our extensive miniature ball bearing range of more than 1000 different types, ranging from 1-10 mm bore (Including inch dimensions), our range also includes Thin section, Three part thrust, Popular metric and any kind of non standard bearing. We are able to design bearings according to your requirements using new materials like ceramic or special steels for applications in Industry, Medicine, Chemistry and Food Processing.

Our technical department can modify any non-standard bearings to your specific requirements, even for small quantities.

For any items not listed in our catalogue, please contact our experienced sales team.



Zen Ball Bearings Shanghai has been awarded the German ISO TUV Rheinland certification for inspection of ZEN products.

This certification is the highest standard a business in our industry can achieve. It is internationally recognised as a guarantee of quality, customer focus and continual improvement.



Gehäuse und Einsätze Housings and Inserts



Wetterbeständig*^▼
Outdoor durability*^▼



Geeignet für niedrige temperaturen*^▼
Suitable for low temperatures*^▼



Geeignet für hohe temperaturen*^
Suitable for high temperatures*^



Lösungsmittelresistent*^▼
Chemical solvent resistant*^▼



Geeignet für hohe tragzahlen*^
Suitable for heavy load rating*^



Ölschmierung*
Oil lubrication*



Fettschmierung*
Grease lubrication*



Gummidichtscheiben verfügbar*
Rubber seal option available*



Metalldeckscheiben verfügbar*
Metal shield option available*

* Stainless Steel Inserts

^ Thermoplastic Pillow Blocks

▼ Stainless Steel Pillow Blocks

www.zen.biz

Rostfreie Gehäuse / Stainless Steel Pillow Blocks

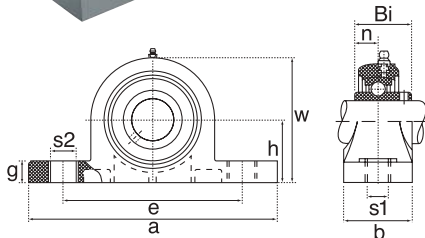
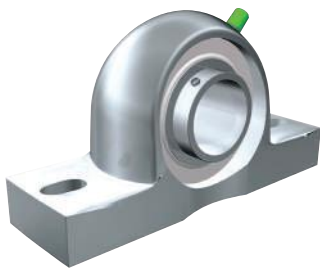

Ref.										Weight	
Type	Da	h	a	e	b	S1	S2	g	w	(kg)	Bearing
SP204	47	33.3	126	95.0	38	11.0	17.5	15.1	65.1	0.69	SUC204
SP205	52	36.5	140	105.0	38	12.5	17.5	16.0	70.0	0.74	SUC205
SP206	62	42.9	165	121.0	48	14.3	21.0	18.0	83.0	1.29	SUC206
SP207	72	47.6	167	127.0	48	14.3	22.0	19.0	94.0	1.42	SUC207
SP208	80	49.2	184	136.5	54	14.3	22.0	19.0	100.0	1.82	SUC208
SP209	85	54.0	190	146.0	54	15.0	22.0	20.0	109.0	2.09	SUC209
SP210	90	57.2	206	159.0	60	18.0	24.0	22.0	114.0	2.38	SUC210
SP211	100	63.5	219	171.0	60	20.0	25.0	23.0	126.0	2.55	SUC211
SP212	110	69.8	241	184.0	70	20.0	25.0	25.0	138.0	3.40	SUC212

3

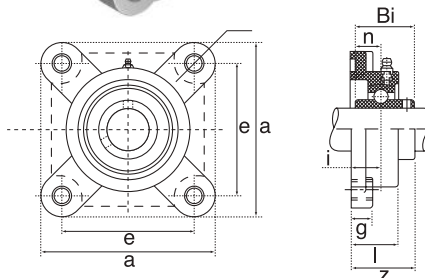

Ref.								Weight	
Type	Da	a	e	i	l	g	s	(kg)	Bearing
SF204	47	86.0	63.5	15.1	25.4	12.0	11.0	0.47	SUC204
SF205	52	95.0	70.0	15.9	27.0	14.0	11.5	0.65	SUC205
SF206	62	108.0	82.5	17.9	30.0	14.0	13.1	0.85	SUC206
SF207	72	117.5	92.0	19.1	33.0	14.3	13.1	1.03	SUC207
SF208	80	130.0	101.6	21.0	36.0	14.3	14.0	1.38	SUC208
SF209	85	137.0	104.8	21.8	37.0	14.3	16.0	1.50	SUC209
SF210	90	143.0	111.0	21.8	38.0	15.1	16.0	1.63	SUC210
SF211	100	162.0	130.0	25.0	43.0	19.5	19.0	3.25	SUC211
SF212	110	175.0	143.0	29.0	48.0	19.5	19.0	4.20	SUC212

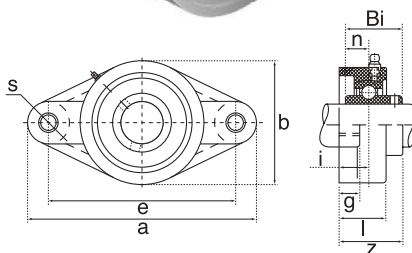

Ref.									Weight	
Type	Da	a	e	i	b	l	g	s	(kg)	Bearing
SFL204	47	112.0	89.7	15.1	60	25.4	11.5	11	0.32	SUC204
SFL205	52	125.0	98.8	15.9	68	27.0	13.0	12	0.44	SUC205
SFL206	62	141.0	116.7	17.9	80	30.0	13.0	12	0.58	SUC206
SFL207	72	155.5	130.2	19.1	90	33.0	14.3	13	0.74	SUC207
SFL208	80	171.5	143.7	21.0	100	36.0	14.3	13	0.99	SUC208
SFL209	85	179.0	148.4	21.8	108	37.0	14.3	16	1.16	SUC209
SFL210	90	189.0	157.0	21.8	115	38.0	15.1	16	1.36	SUC210
SFL211	100	224.0	184.0	25.0	130	43.0	16.0	19	2.20	SUC211
SFL212	110	250.0	202.0	29.0	140	48.0	18.0	23	2.65	SUC212

Thermoplastische Gehäuse / Thermoplastic Pillow Blocks

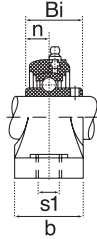
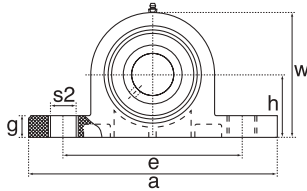

4

Ref.												Weight	
Type	h	a	e	b	S1	S2	g	w	Bi	n	(kg)	Bearing	
TP201	33.3	127.0	95	38	11	14	14.2	65.0	31.0	12.7	0.12	SUC201	
TP202	33.3	127.0	95	38	11	14	14.2	65.0	31.0	12.7	0.12	SUC202	
TP203	33.3	127.0	95	38	11	14	14.2	65.0	31.0	12.7	0.12	SUC203	
TP204	33.3	127.0	95	38	11	14	14.2	69.5	31.0	12.7	0.12	SUC204	
TP205	36.5	140.6	105	38	11	14	14.5	71.0	34.0	14.3	0.14	SUC205	
TP206	42.9	163.0	118	46	14	18	17.8	84.0	38.1	15.9	0.20	SUC206	
TP207	47.6	168.0	127	48	14	18	18.0	94.5	42.9	17.5	0.25	SUC207	
TP208	49.2	184.0	137	54	14	18	19.5	99.0	49.2	19.0	0.35	SUC208	
TP209	54.0	192.0	146	54	17	20	23.0	106.0	49.2	19.0	0.45	SUC209	
TP210	57.2	206.0	159	60	17	20	23.0	114.0	51.6	19.0	0.55	SUC210	
TP211	63.5	219.0	171	60	20	23	23.0	125.0	55.6	22.2	1.38	SUC211	
TP212	69.5	241.0	184	70	20	23	25.0	138.0	65.1	25.4	1.52	SUC212	

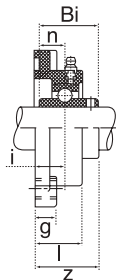
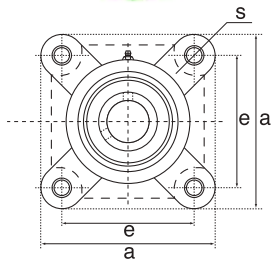

Ref.												Weight	
Type	a	e	g	l	s	z	i	Bi	n	(kg)	Bearing		
TF201	86	63.5	13.4	27.8	11	36.3	18.0	31.0	12.7	0.12	SUC201		
TF202	86	63.5	13.4	27.8	11	36.3	18.0	31.0	12.7	0.12	SUC202		
TF203	86	63.5	13.4	27.8	11	36.3	18.0	31.0	12.7	0.12	SUC203		
TF204	86	63.5	13.4	27.8	11	36.3	18.0	31.0	12.7	0.12	SUC204		
TF205	95	70.0	14.0	28.0	11	36.7	17.0	34.0	14.3	0.15	SUC205		
TF206	107	83.0	14.3	31.5	11	41.4	19.2	38.1	15.9	0.18	SUC206		
TF207	118	92.0	15.5	34.8	13	46.9	21.5	42.9	17.5	0.26	SUC207		
TF208	130	102.0	17.0	37.5	14	53.2	23.0	49.2	19.0	0.33	SUC208		
TF209	137	105.0	19.0	41.0	17	54.2	24.0	49.2	19.0	0.42	SUC209		
TF210	143	111.0	21.0	43.0	17	57.6	25.0	51.6	19.0	0.51	SUC210		
TF211	162	130.0	20.0	43.0	19	58.4	25.0	55.6	22.2	1.40	SUC211		
TF212	175	143.0	20.0	48.0	19	68.7	29.0	65.1	25.4	1.60	SUC212		

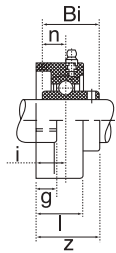
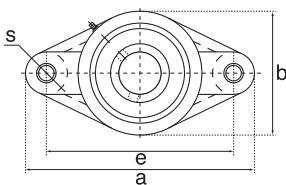

Ref.												Weight	
Type	a	e	b	g	l	s	z	i	Bi	n	(kg)	Bearing	
TFL201	113	90	64.0	11.4	26.5	11	33.7	15.4	31.0	12.7	0.08	SUC201	
TFL202	113	90	64.0	11.4	26.5	11	33.7	15.4	31.0	12.7	0.08	SUC202	
TFL203	113	90	64.0	11.4	26.5	11	33.7	15.4	31.0	12.7	0.08	SUC203	
TFL204	113	90	64.0	11.4	26.5	11	33.7	15.4	31.0	12.7	0.08	SUC204	
TFL205	131	99	69.6	13.5	29.1	11	36.7	17.0	34.0	14.3	0.10	SUC205	
TFL206	148	117	80.0	13.3	30.5	11	41.2	19.0	38.1	15.9	0.13	SUC206	
TFL207	164	130	90.0	16.1	32.9	13	43.4	19.0	42.9	17.5	0.16	SUC207	
TFL208	176	144	100.0	20.0	37.5	14	51.7	21.5	49.2	19.0	0.24	SUC208	
TFL209	188	148	108.0	21.0	41.0	17	54.2	24.0	49.2	19.0	0.32	SUC209	
TFL210	197	157	115.0	21.0	43.0	17	57.6	25.0	51.6	19.0	0.42	SUC210	
TFL211	224	184	130.0	18.0	43.0	19	58.4	25.0	55.6	22.2	1.40	SUC211	
TFL212	250	202	140.0	18.0	48.0	19	68.7	29.0	65.1	25.4	1.60	SUC212	

Thermoplastische Gehäuse / Thermoplastic Pillow Blocks

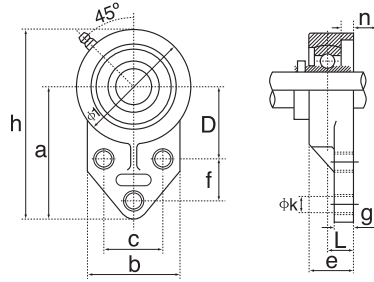

5

Housing No.	Bearing Bore Diameter (mm)	A	B	C	D	E	F	G	H	I	J	K	M	N	Bolt dia	Weight Kg
FBL201	12	76.2	62	38.1	42.9	33.7	22.2	11.4	108	63.5	26.5	10.7	18.3	12.7	M10	0.08
FBL202	15	76.2	62	38.1	42.9	33.7	22.2	11.4	108	63.5	26.5	10.7	18.3	12.7	M10	0.08
FBL203	17	76.2	62	38.1	42.9	33.7	22.2	11.4	108	63.5	26.5	10.7	18.3	12.7	M10	0.08
FBL204	20	76.2	62	38.1	42.9	33.7	22.2	11.4	108	63.5	26.5	10.7	18.3	12.7	M10	0.08
FBL205	25	85.7	63.5	41.3	46	41.2	28.6	11.4	120.6	70	34	10.7	19.7	14.3	M10	0.11
FBL206	30	96.5	76	47.6	52.4	41.5	31.8	13.3	138.5	83	32	10.7	22.2	15.9	M10	0.16
FBL207	35	109.5	89	50.8	60.3	47.1	31.8	16.1	157	95	36.5	13.1	25.4	17.5	M12	0.23

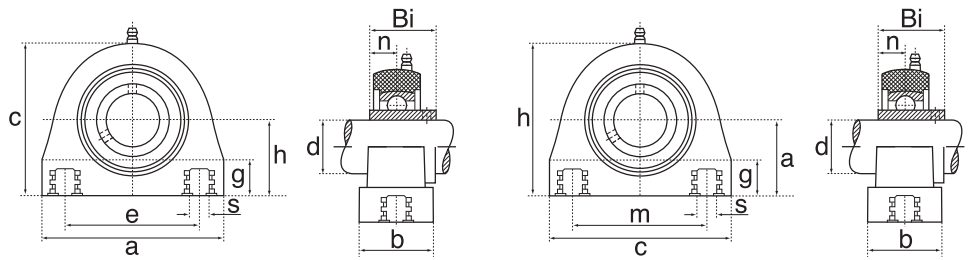

Housing No.	Bearing Bore Diameter d (mm)	a	e	h	b	s	c	Bi	n	g	Weight Kg
PAL204	20	76	52	33.3	38	M8	64	31	12.7	13	0.09
PAL205	25	84	56	36.5	38	M10	72	34.1	14.3	13	0.12
PAL206	30	94	66	42.9	48	M10	84	38.1	15.9	16	0.18
PAL207	35	110	80	47.6	48	M10	95	49.2	17.5	18	0.26
PAL208	40	116	84	49.2	54	M12	100	49.2	19	20	0.3
PAL209	45	120	90	54.2	54	M12	108	49.2	19	20	0.35
PAL210	50	130	94	57.2	60	M16	116	51.6	19	22	0.45

Rostfreie Gehäuse / Stainless Steel Pillow Blocks

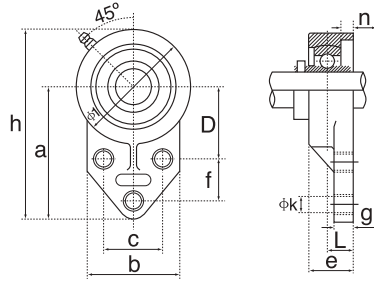

6

Housing No.	Da	h	a	e	j	l	g	L	c	s	f	b	Weight Kg	Bearing No.
SFB204	47	42.9	108	38.1	22.2	16	8	25.4	52	10	60	63	0.39	SUC204
SFB205	52	46	121	41.3	28.6	17	9.5	29	52	10	64	70	0.54	SUC205
SFB206	62	52.4	137	47.6	31.8	19	9.5	32	55	10	70	83	0.77	SUC206
SFB207	72	60.3	156	50.8	31.8	21	13.5	37	62	13	82.5	95	1.16	SUC207
SFB208	80	60	164	50	41	21	16	34	72	11	78	100	1.65	SUC208
SFB209	85	65	174	54	42.9	21	18	34	76	11	80	106	1.91	SUC209
SFB210	90	74.6	191	69.9	41.3	21	13	38	82	13	102	118	2.34	SUC210
SFB211														SUC211
SFB212														SUC212

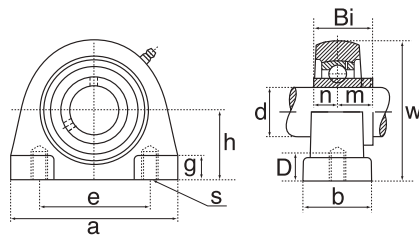

Housing No.	Da	h	a	e	b	g	t	d	w	Be	Weight Kg	Bearing No.
SPA201-204	47	30.2	74	52	38	11	M10	13	62	17	0.57	SS-UC201-204
SPA205	52	36.5	80	56	38	12	M10	15	72	17	0.67	SS-UC205
SPA206	62	42.9	94	66	48	12	M14	18	84	19	0.8	SS-UC206
SPA207	72	47.9	110	80	48	12	M14	20	95	20	1.38	SS-UC207
SPA208	80	49.2	116	84	54	12	M14	20	100	21	1.75	SS-UC208
SPA209	85	54.2	120	90	54	12	M14	25	108	22	1.8	SS-UC209
SPA210	90	57.2	130	94	60	14	M16	25	116	23	2.4	SS-UC210
SPA211	100	63.5	140	104	66	14	M16	25	125	24	2.8	SS-UC211
SPA212	110	69.9	150	114	68	15	M16	25	138	26	3.7	SS-UC212

Rostfreie Gehäuse / Stainless Steel Pillow Blocks

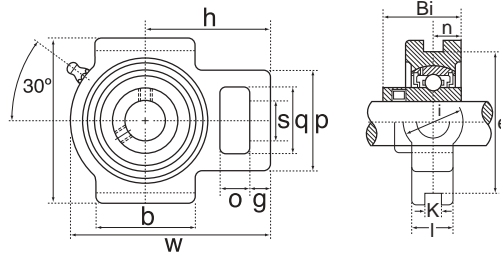

7

Bearing No.	Shaft d (mm)	o	g	p	q	s	b	k	e	a	w	l	l	h	Bi	n	Weight Kg
ST201	20	16	10	51	32	19	51	12	76	89	94	32	21	61	31	12.7	0.73
ST202	25	16	10	51	32	19	51	12	76	89	97	32	24	62	34.1	14.3	0.73
ST203	30	16	10	56	37	22	57	12	89	102	113	37	28	70	38.1	15.9	0.73
ST204	35	16	13	64	37	22	64	12	89	102	129	37	30	78	42.9	17.5	0.73
ST205	40	19	16	83	49	29	83	16	102	114	144	49	33	88	49.2	19	0.8
ST206	45	19	16	83	49	29	83	16	102	117	144	49	35	87	49.2	19	1.15
ST207	50	19	16	83	49	29	86	16	102	117	149	49	37	90	51.6	19	1.35
ST208	55	25	19	102	64	35	95	22	130	146	171	64	38	106	55.6	22.2	2.05
ST209	60	32	19	102	64	35	102	22	130	146	194	64	42	119	65.1	25.4	2.1
ST210	50	19	16	83	49	29	86	16	102	117	149	49	37	90	51.6	19	2.1
ST211	55	25	19	102	64	35	95	22	130	146	171	64	38	106	55.6	22.2	
ST212	60	32	19	102	64	35	102	22	130	146	194	64	42	119	65.1	25.4	

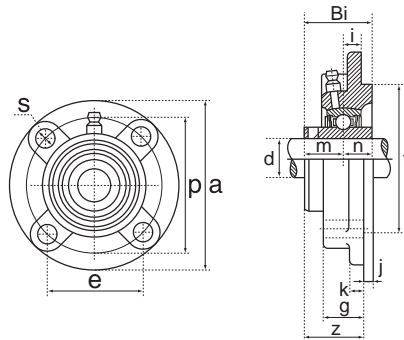

Housing No.	Da	p	e	l	s	j	k	g	f	n	Weight Kg	Bearing No.
SFC201	47	78	55.1	10	12	5	7	20.5	62	12.7	SUC201	0.72
SFC202	47	78	55.1	10	12	5	7	20.5	62	12.7	SUC202	0.72
SFC203	47	78	55.1	10	12	5	7	20.5	62	12.7	SUC203	0.72
SFC204	47	78	55.1	10	12	5	7	20.5	62	12.7	SUC204	0.72
SFC205	52	90	63.6	10	12	6	7	21	70	14.3	SUC205	0.98
SFC206	62	100	70.7	10	12	8	8	23	80	15.9	SUC206	1.3
SFC207	72	110	77.8	11	14	8	9	26	90	17.5	SUC207	1.8
SFC208	80	120	84.8	11	14	10	9	26	100	19	SUC208	2
SFC209	85	132	93.3	10	16	12	14	26	105	19	SUC209	2.9
SFC210	90	138	97.6	10	16	12	14	28	110	19	SUC210	2.9
SFC211	100	150	106.1	13	19	12	15	31	125	22.2	SUC211	4.5
SFC212	110	160	113.1	17	19	12	15	36	135	25.4	SUC212	5.1

Rostfreie Lagereinsätze / Stainless Steel Inserts

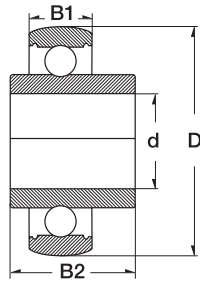
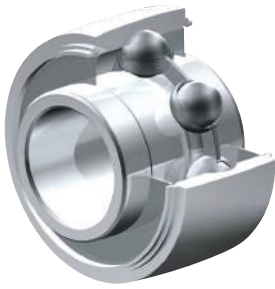

8

Dimension (mm)				Designation/Type	* Load Rating	
d	D	B1	B2		C, dyn. N	C, stat. N
12.0	47.0	17.0	31.0	SUC 201	7500	4500
15.0	47.0	17.0	31.0	SUC 202	7500	4500
17.0	47.0	17.0	31.0	SUC 203	7500	4500
20.0	47.0	17.0	31.0	SUC 204	10000	6300
25.0	52.0	17.0	34.1	SUC 205	11000	7100
30.0	62.0	19.0	38.1	SUC 206	15200	10200
35.0	72.0	20.0	42.9	SUC 207	20100	18100
40.0	80.0	21.0	49.2	SUC 208	23000	18100
45.0	85.0	22.0	49.2	SUC 209	25600	18100
50.0	90.0	23.0	31.6	SUC 210	27500	20200
55.0	100.0	25.0	55.6	SUC 211	33500	29200
60.0	110.0	27.0	65.1	SUC 212	36800	32800

Dimension (mm)				Designation/Type	* Load Rating	
d	D	B1	B2		C, dyn. N	C, stat. N
20.0	52.0	17.0	34.1	SUCX04	13900	7800
25.0	62.0	19.0	38.1	SUCX05	15400	10200
30.0	72.0	20.0	42.9	SUCX06	20300	14000
35.0	80.0	21.0	49.2	SUCX07	23000	16000
40.0	85.0	22.0	49.2	SUCX08	25600	18100
45.0	90.0	24.0	51.6	SUCX09	27500	20200
50.0	100.0	25.0	55.6	SUCX10	34000	25500

www.zen.biz

Alle Rechte vorbehalten, kein Teil des Katalogs darf in irgendeiner Form (Druck, Fotokopie, Mikrofilm oder in einem anderen Verfahren) ohne Genehmigung reproduziert oder unter Verwendung elektronischer Systeme verarbeitet, vervielfältigt oder verbreitet werden.

Copyright reserved. No part of the catalogue is to be copied, extracted or modified without explicit permission from the copyright holder.

v.10 / 12



Bearings for your future